

WIND ROSE

SRE

September, 1957

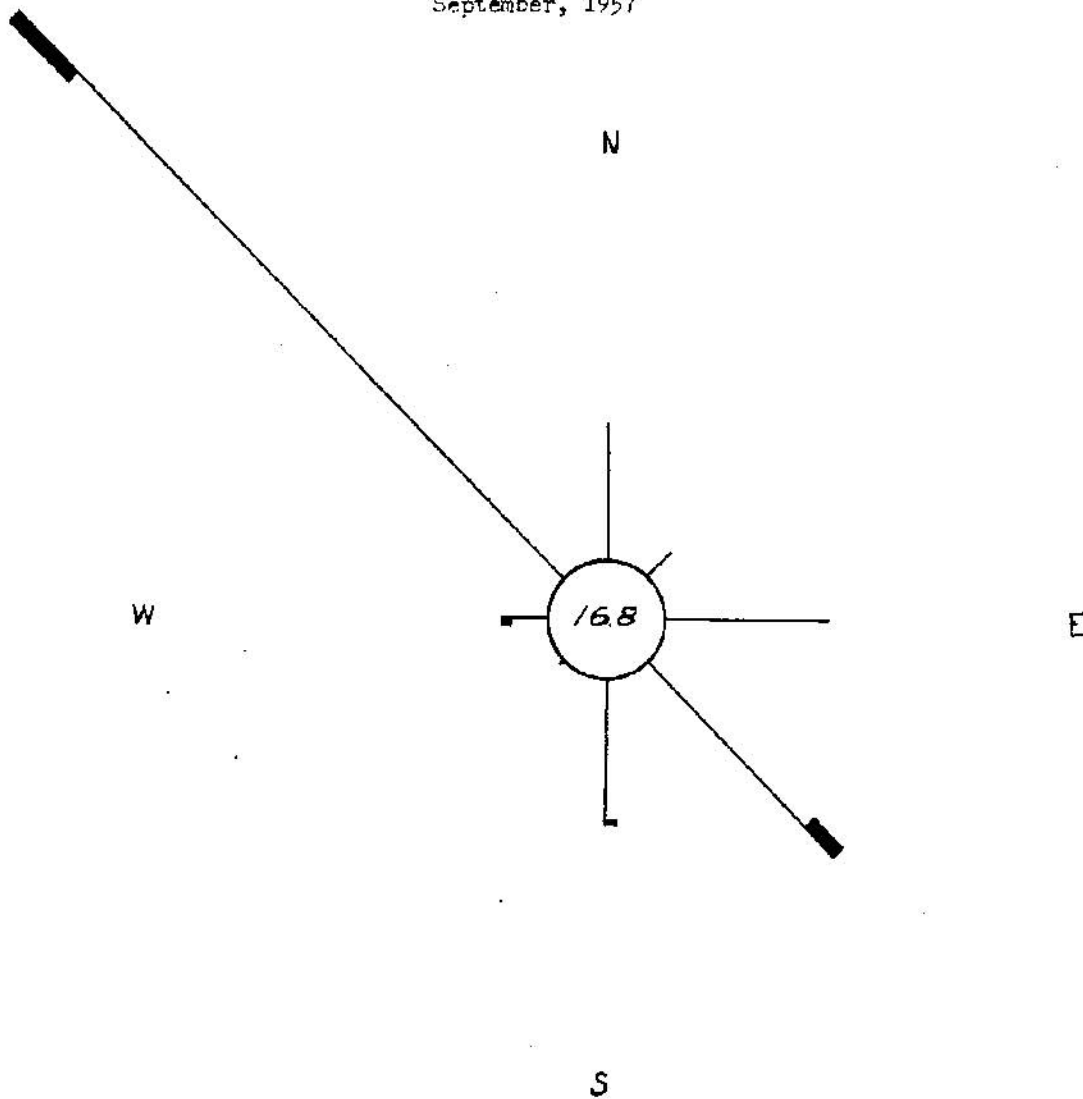

90 of calms (0 - 3 mph)

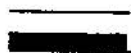

4 - 15 mph
16 - 31 mph

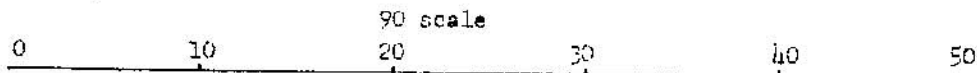

Measured from circumference of circle

WIND ROSE
SRE - January 1960

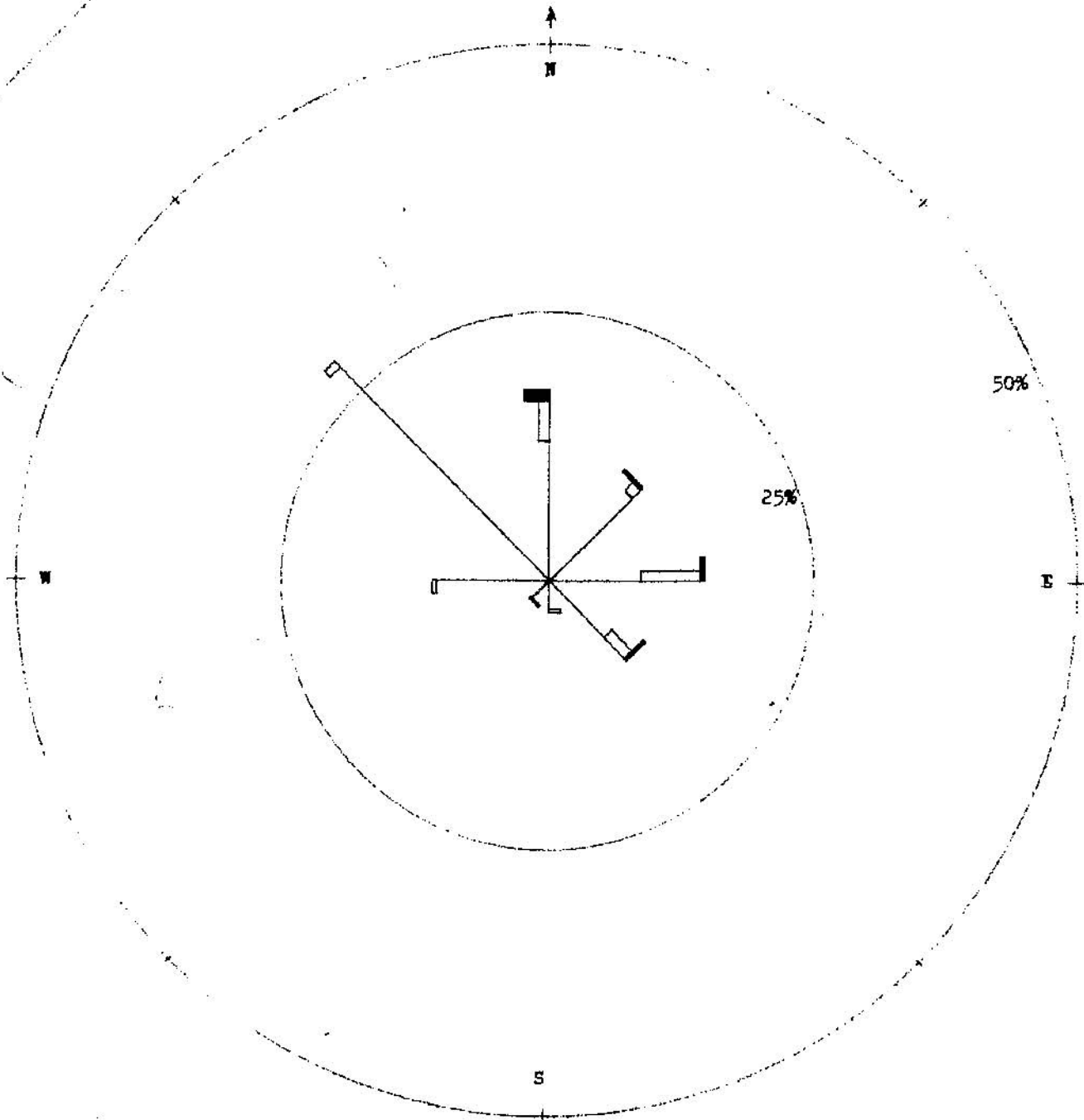

LEGEND

3 -15	15-31	31+

Windspeed
in miles per hour

Calm 0-3 MPH 0%

Values indicated represent 88%
of possible monthly observations

WIND ROSE

SRE - February 60

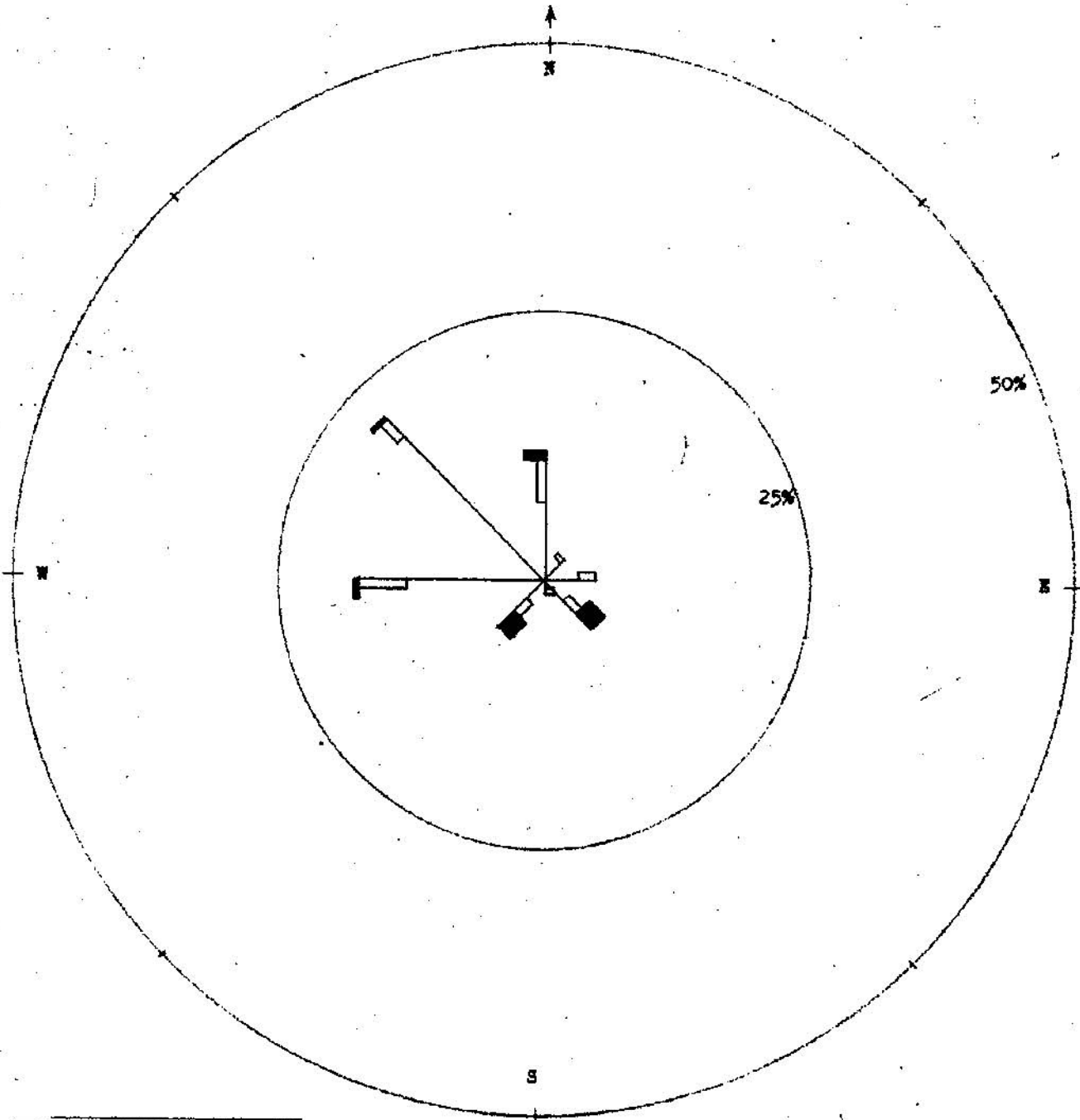

LEGEND

3 -15 15-31 31+
Windspeed
in miles per hour

Values indicated represent 59%
of possible monthly observations.

Calm 0-3 MPH 23 %

WIND ROSE

SRE - March 60

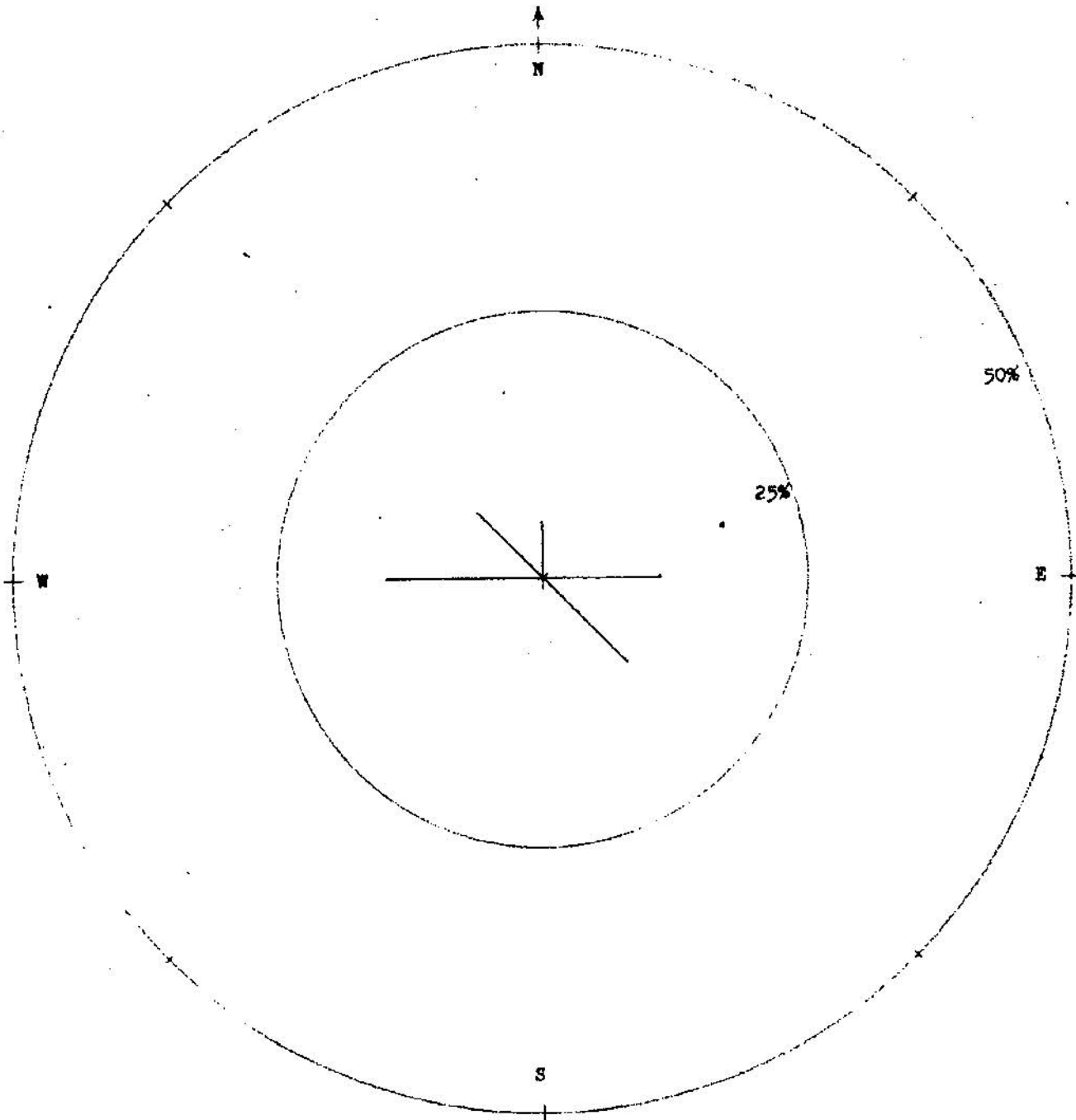

LEGEND

3	-15	15-31	31+
---	-----	-------	-----

Windspeed
in miles per hour

Values indicated represent 21%
of possible monthly observations.

Calm 0-3 MPH 48%

WIND ROSE

SRE - April 1960

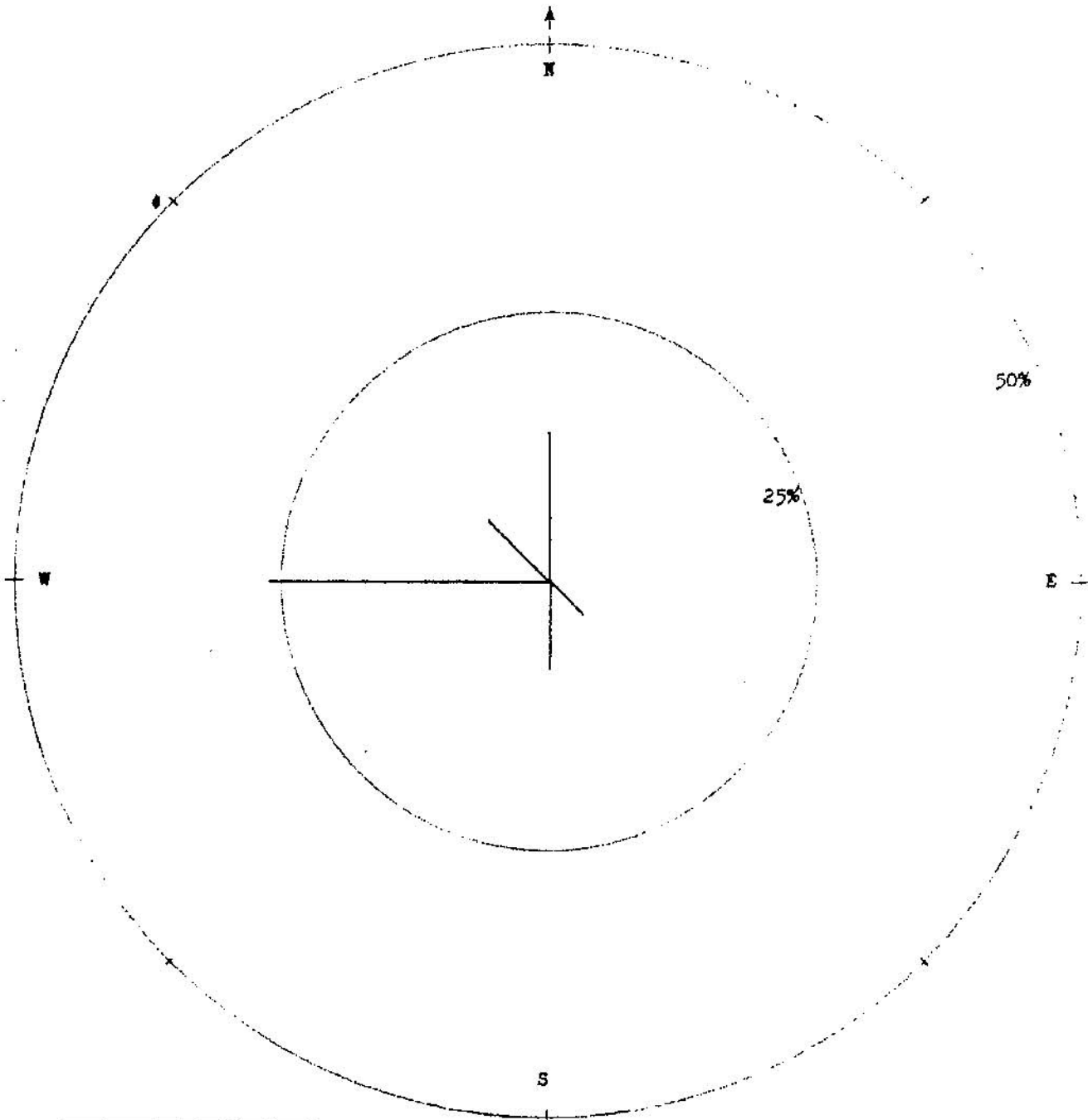

LEGEND

3-15 15-31 31+
Windspeed
in miles per hour

Calm 0-3 MPH 35%

Values indicated represent 9.7% of possible monthly observations.

WIND ROSE

SRE - June 1960

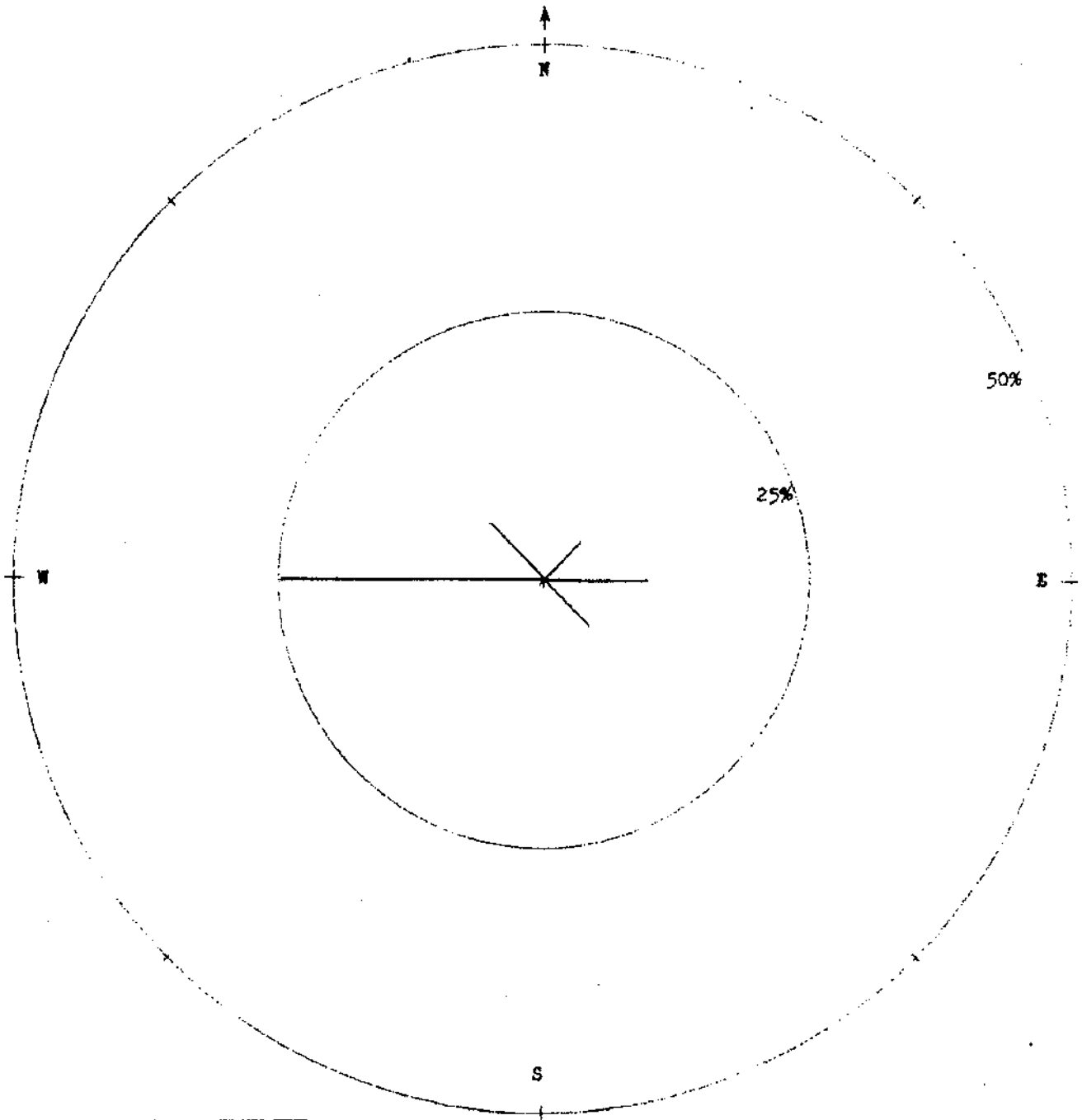

LEGEND

3 -15 15-31 31+
Windspeed
in miles per hour

Calm 0-3 MPH 47.4%

Values indicated represent 80% of
possible monthly observations.

WIND ROSE
SRE JULY 1960

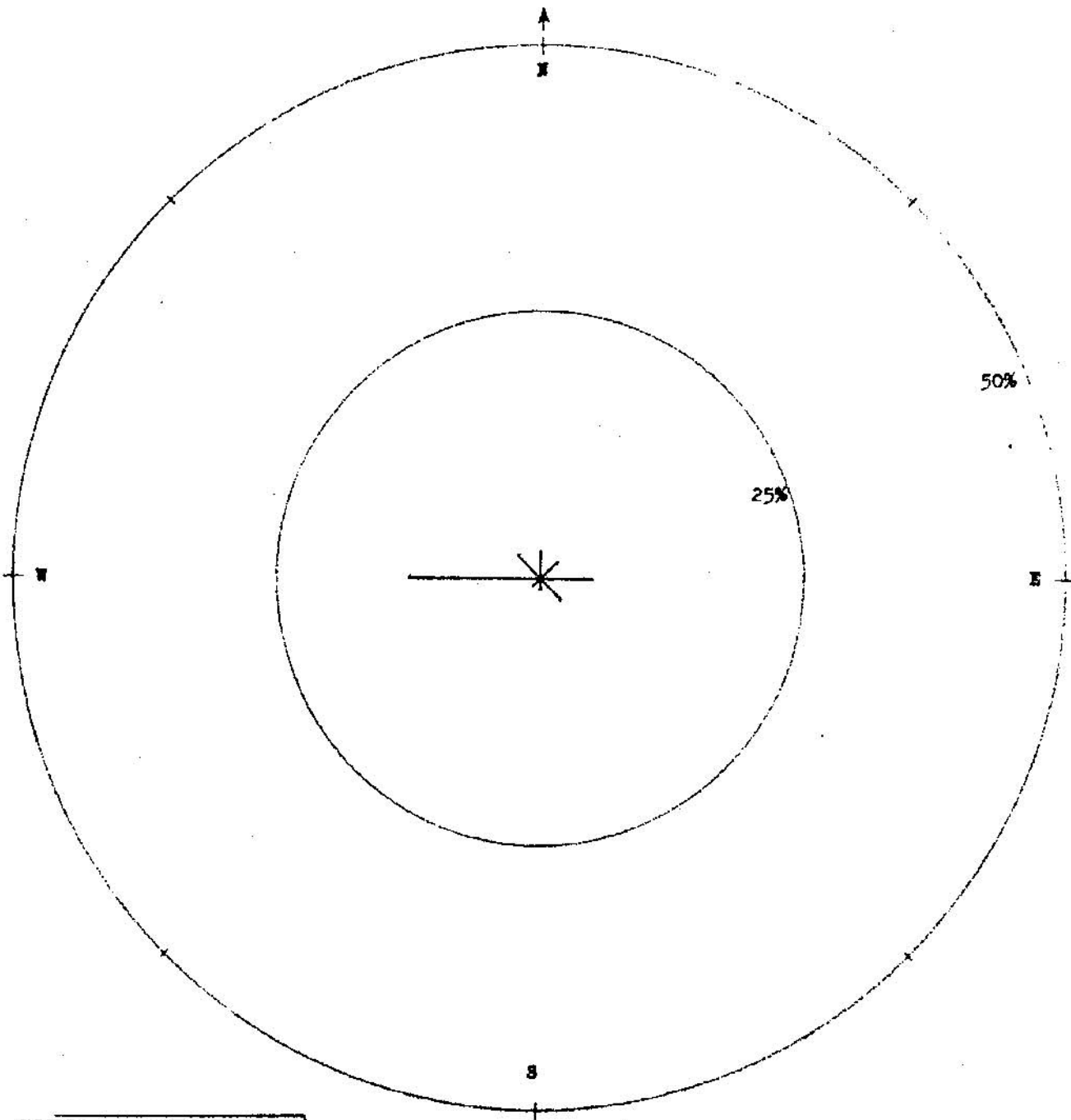

LEGEND

3 -15	15-31	31+
Windspeed in miles per hour		

Values indicated represent 55.4% of possible monthly observations.

Calm 0-3 MPH 43.6

WIND ROSE
SRE - November 1958

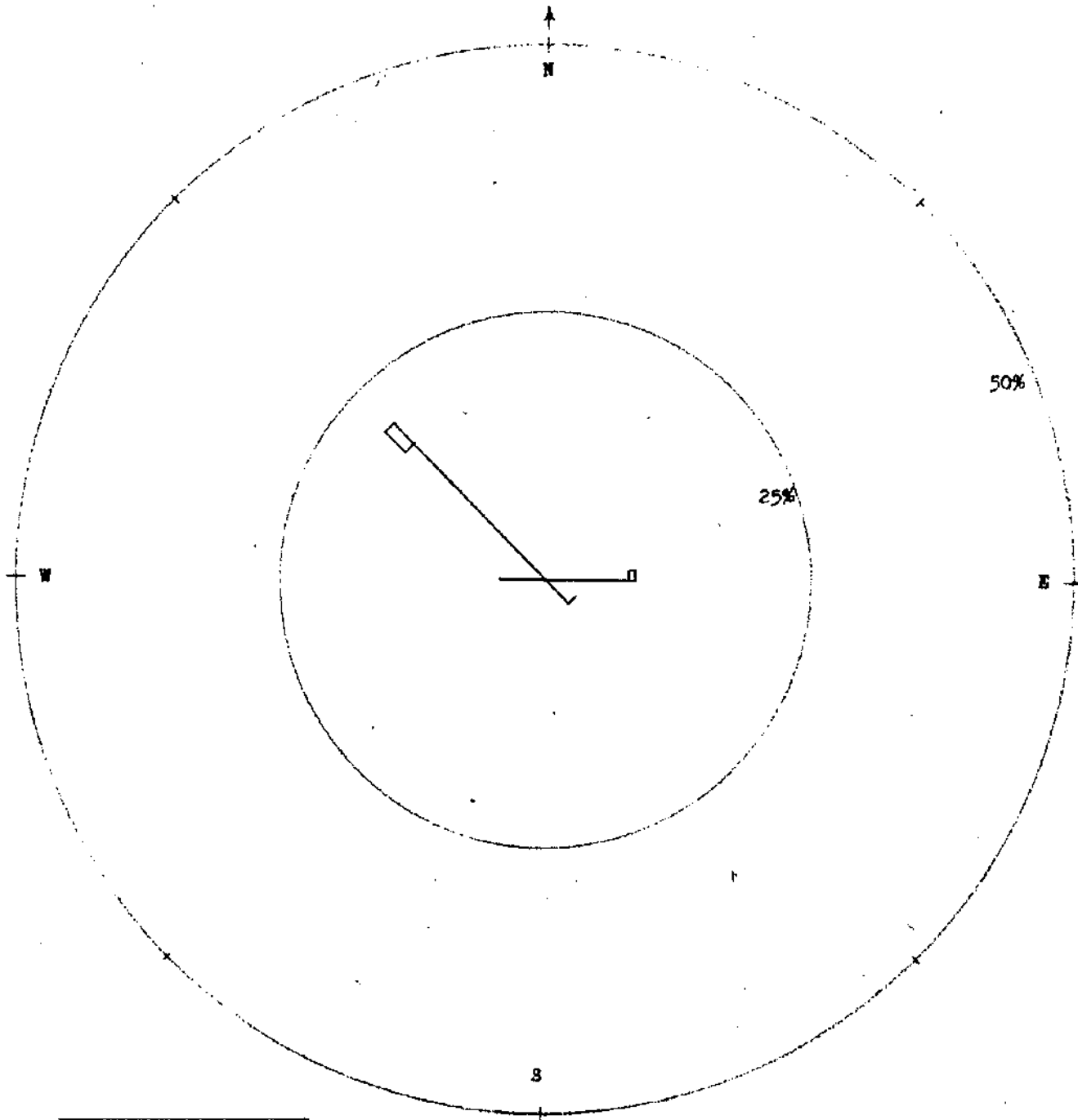

LEGEND

3 -15	15-31	31+
Windspeed in miles per hour		

Values indicated represent 87%
of possible monthly observations.

Calm 0-3 MPH 64%

WIND ROSE
SRE - October 1958

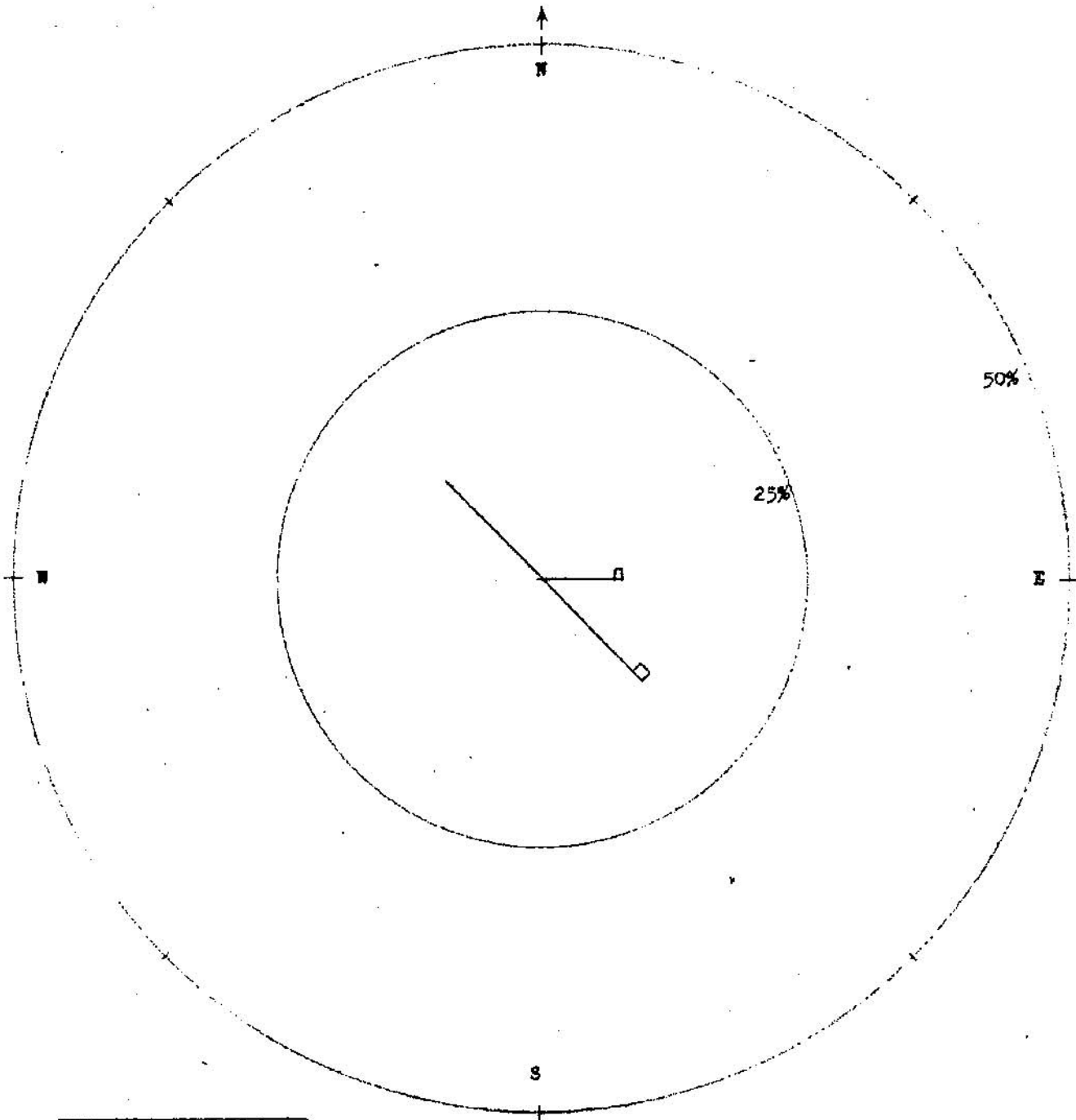

LEGEND

3 -15	15-31	31+
-------	-------	-----

Windspeed
in miles per hour

Values indicated represent 73%
of possible monthly observations.

Calm 0-3 MPH 67%

WIND ROSE
SRE - September 1958

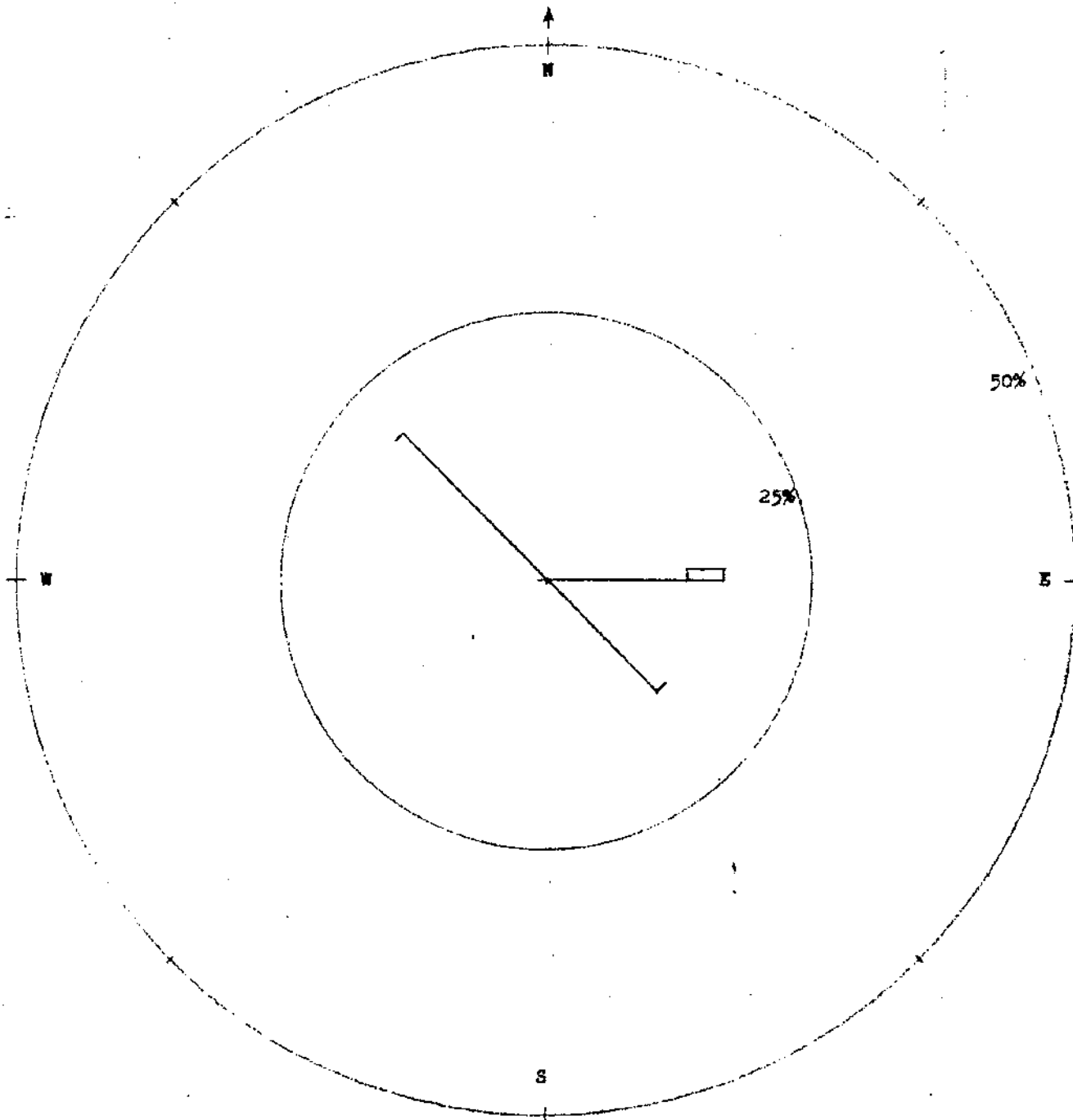

LEGEND			
3	-15	15-31	31+
Windspeed in miles per hour			

Values indicated represent 63%
of possible monthly observations.

Calm 0-3 MPH 49%

WIND ROSE
SRE - August 1958

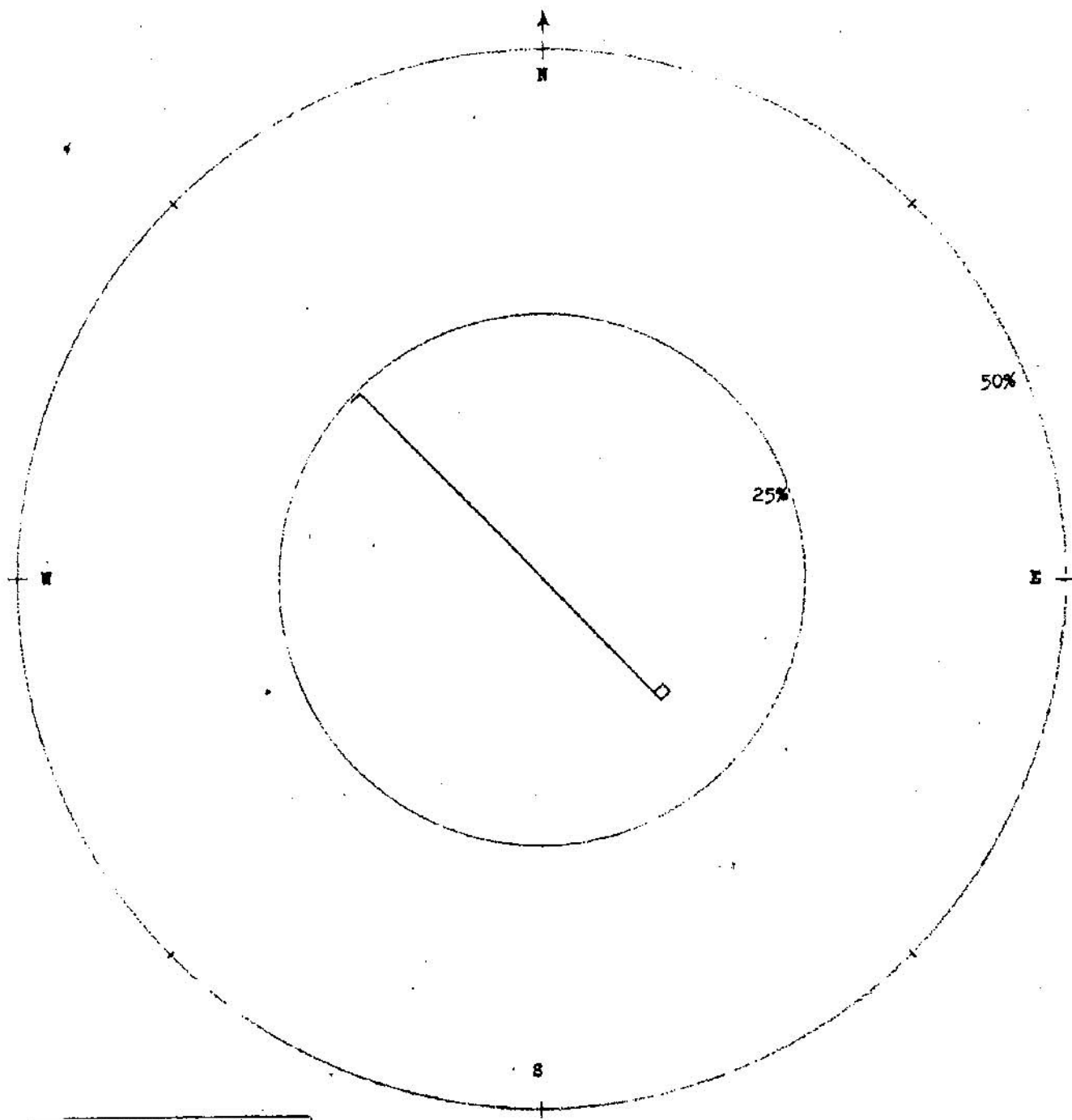

LEGEND

3 -15	15-31	31+

Windspeed
in miles per hour

Values indicated represent 60%
of possible monthly observations.

Calm 0-3 MPH 60%

WIND ROSE
SRE - July 1958

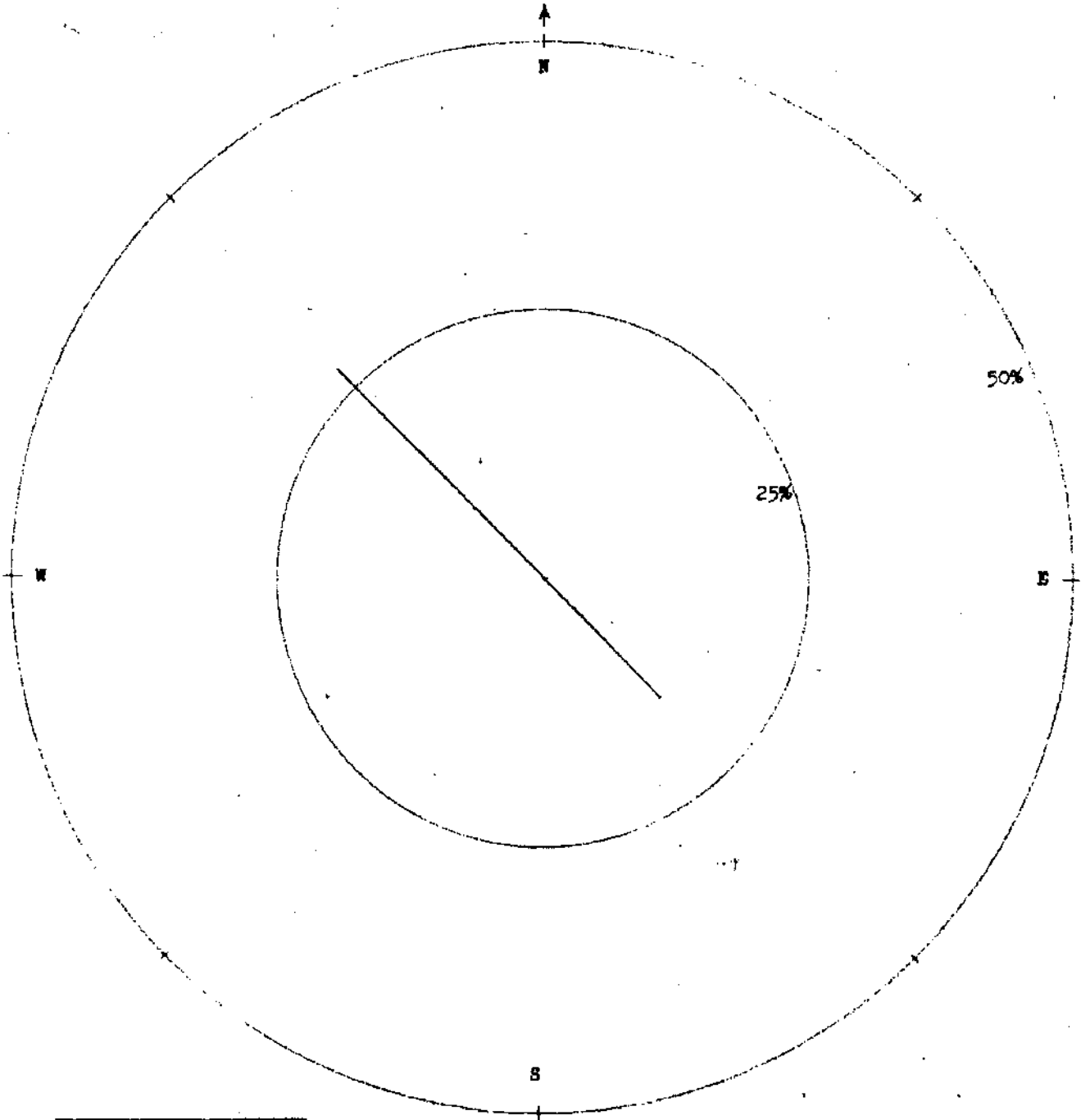

LEGEND

3	-15	15-31	31+
Windspeed in miles per hour			

Calm 0-3 MPH 57%

Values indicated represent 87%
of possible monthly observations.

WIND ROSE
SRE
JUNE 1958

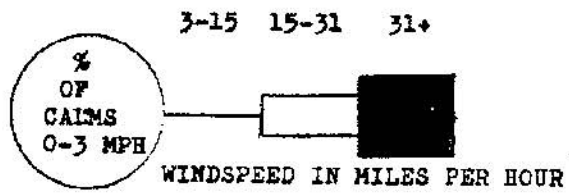
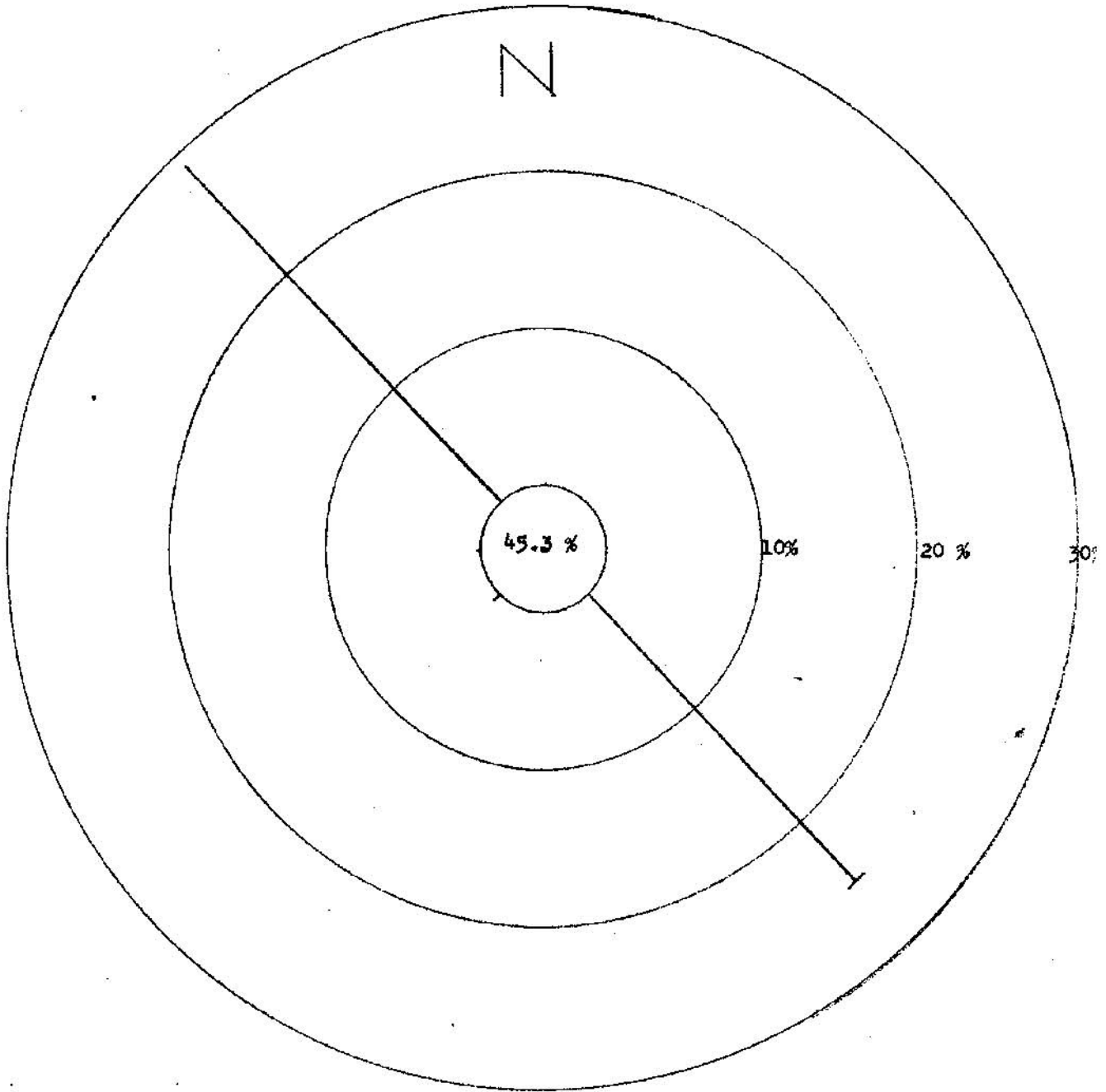

WIND ROSE
SRE - May 1958

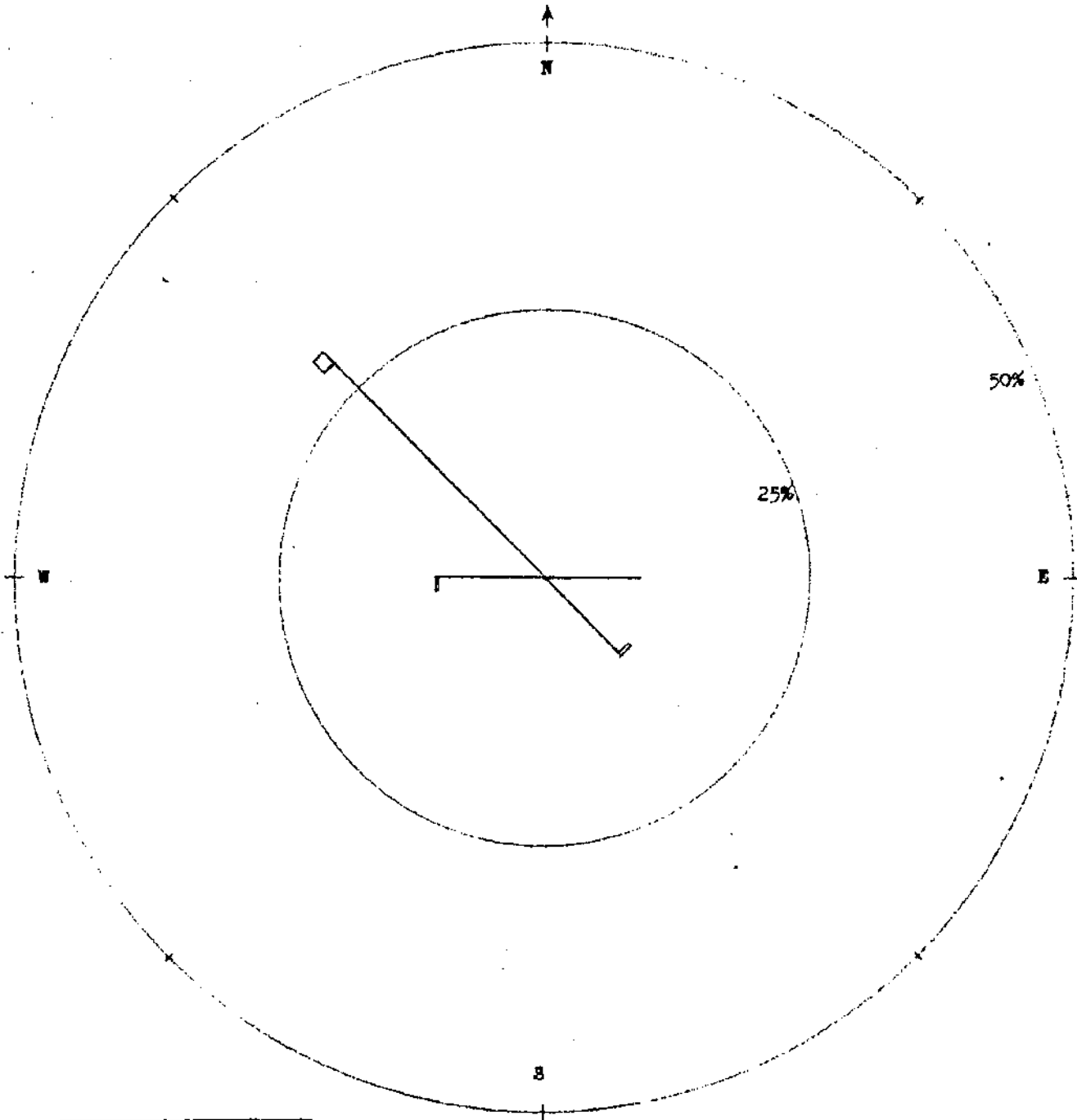

LEGEND

3-15	15-31	31+
------	-------	-----

Wind speed
in miles per hour

Calm 0-3 MPH 41%

Values indicated represent 62%
of possible monthly observations

WIND ROSE
 SEE - April 1958

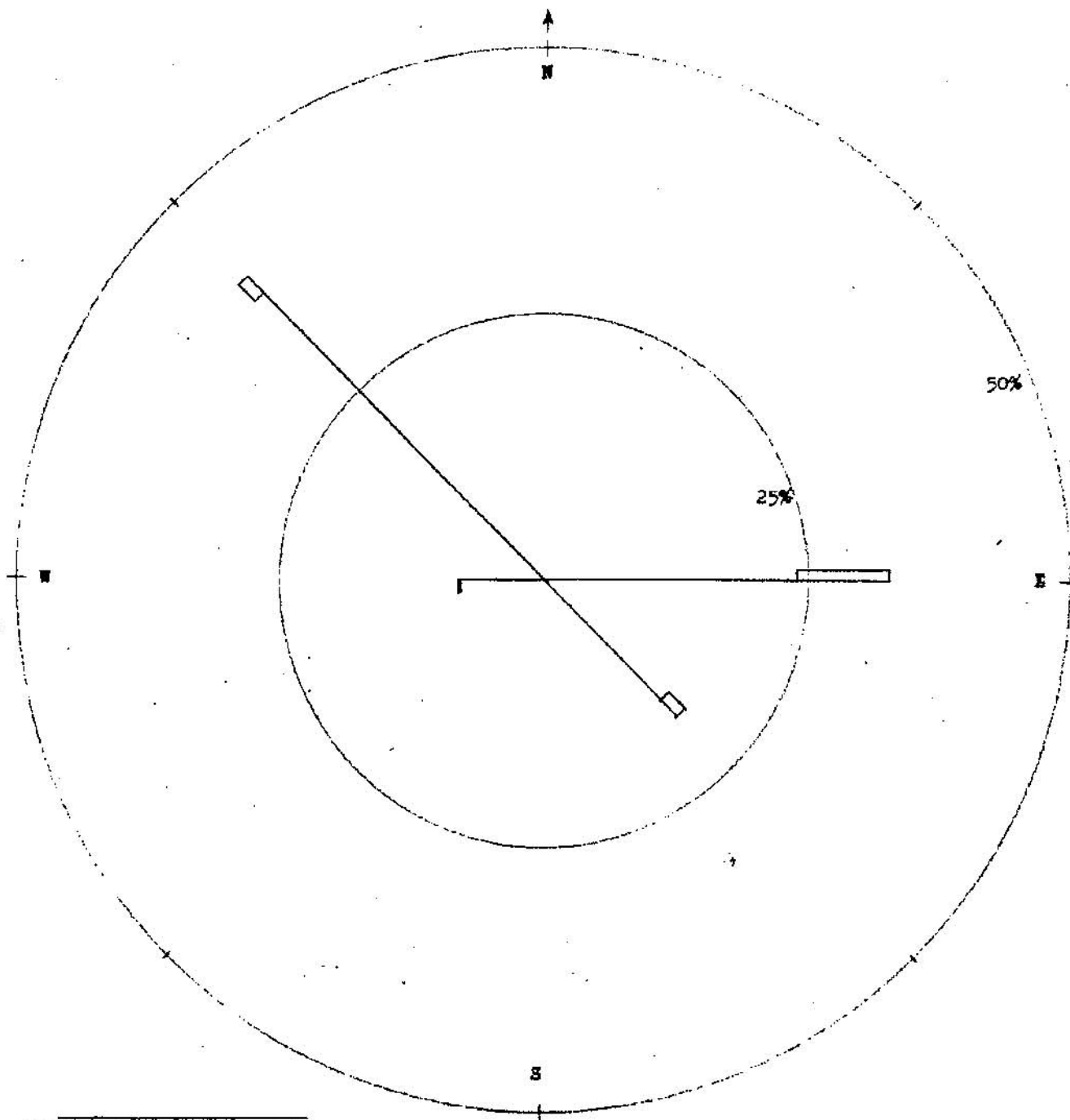

LEGEND

3 -15	15-31	31+

Windspeed
 in miles per hour

Calm 0-3 MPH 2%

Values indicated represent 52%
 of possible monthly observations.

WIND ROSE
SRE
MARCH 1958

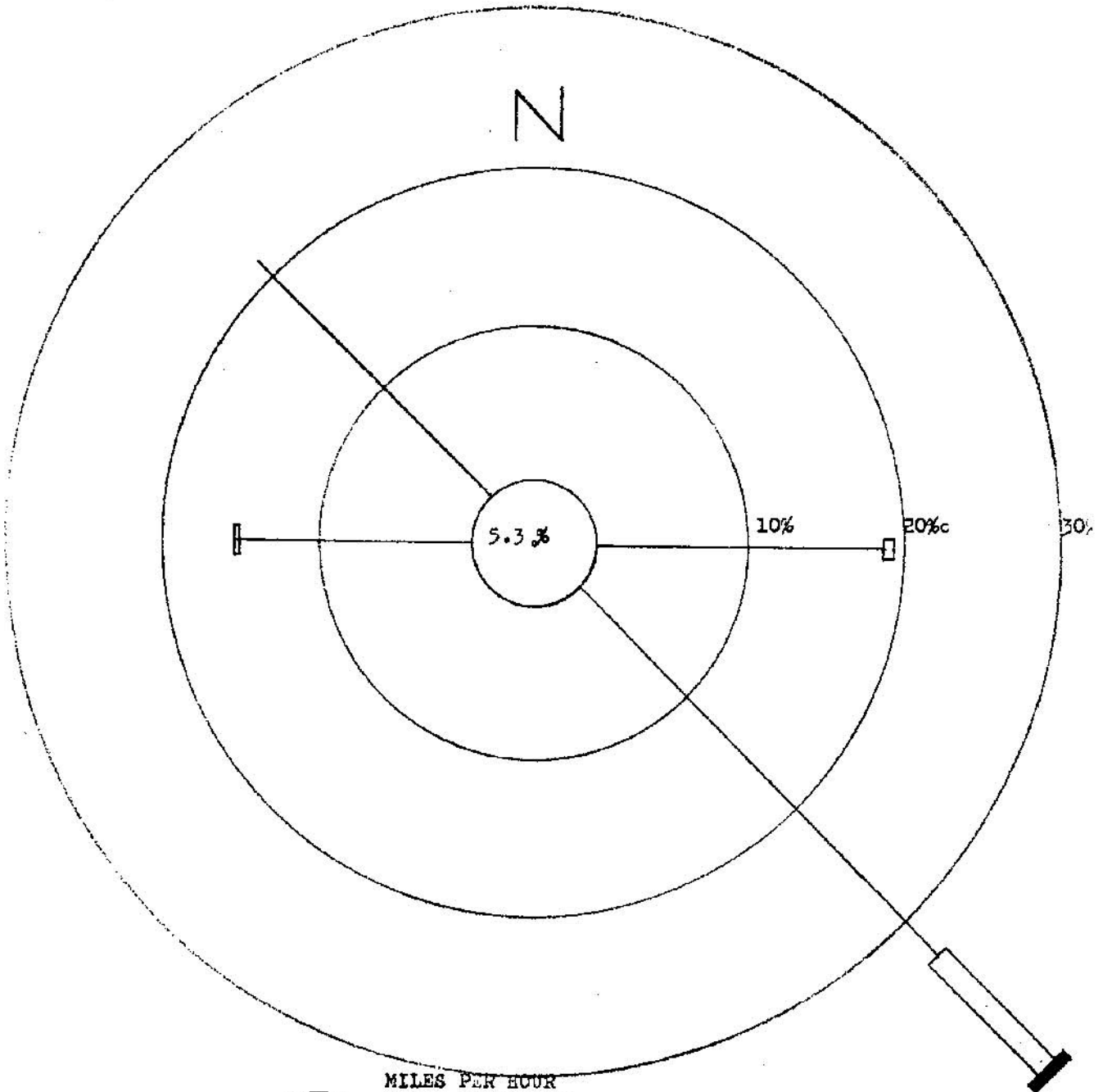

MILES PER HOUR
3-15 15-31 31+

%
OF CALMS
0-3MPH

WIND ROSE
SRE
FEBRUARY 1958

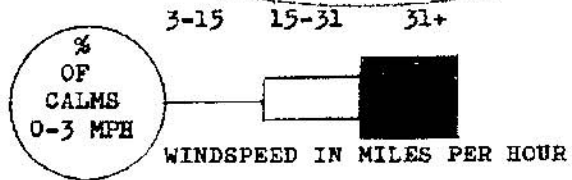
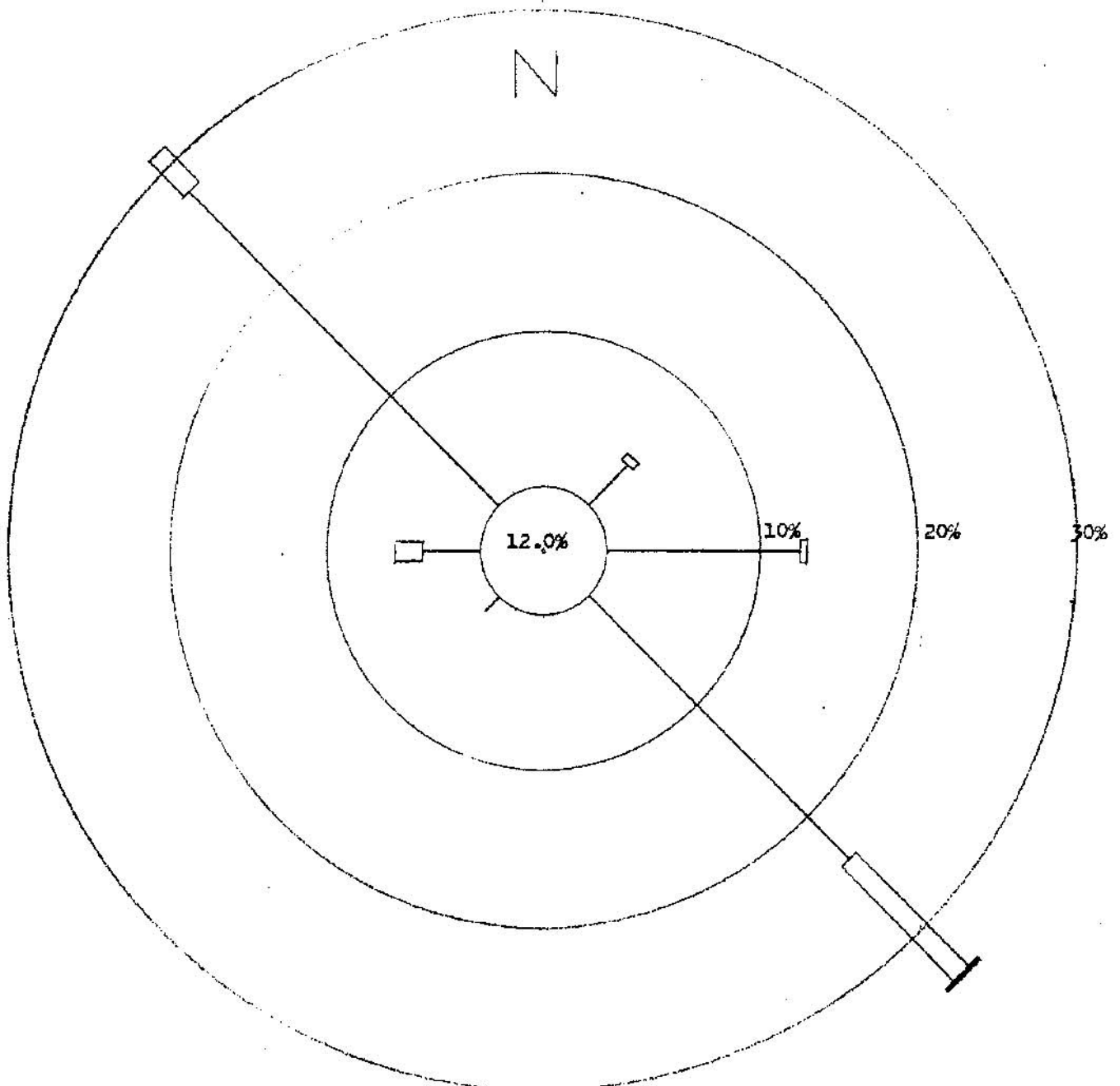

WIND ROSE - SRE
October, 1957

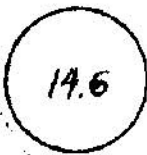
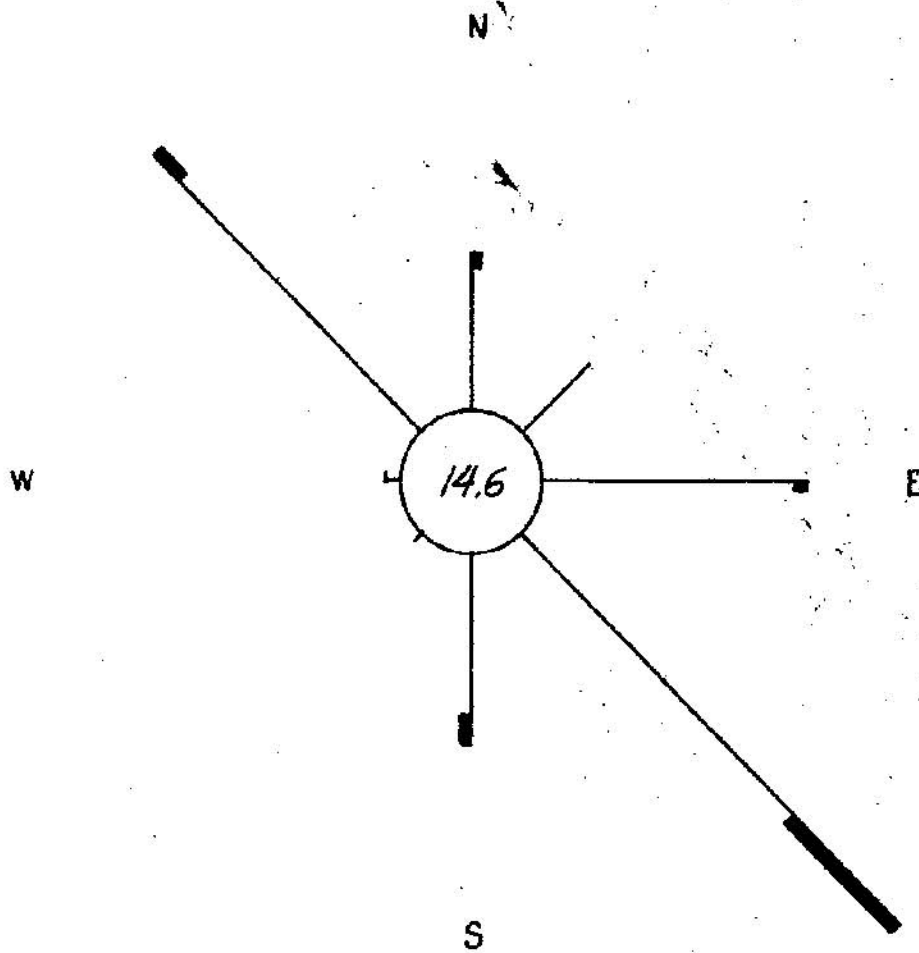

% of calms (0 - 3 mph)

4 - 15 mph

16 - 31 mph

% scale



Measured from circumference of circle

WIND ROSE
 SRE
 1 JULY TO 31 DECEMBER 1957

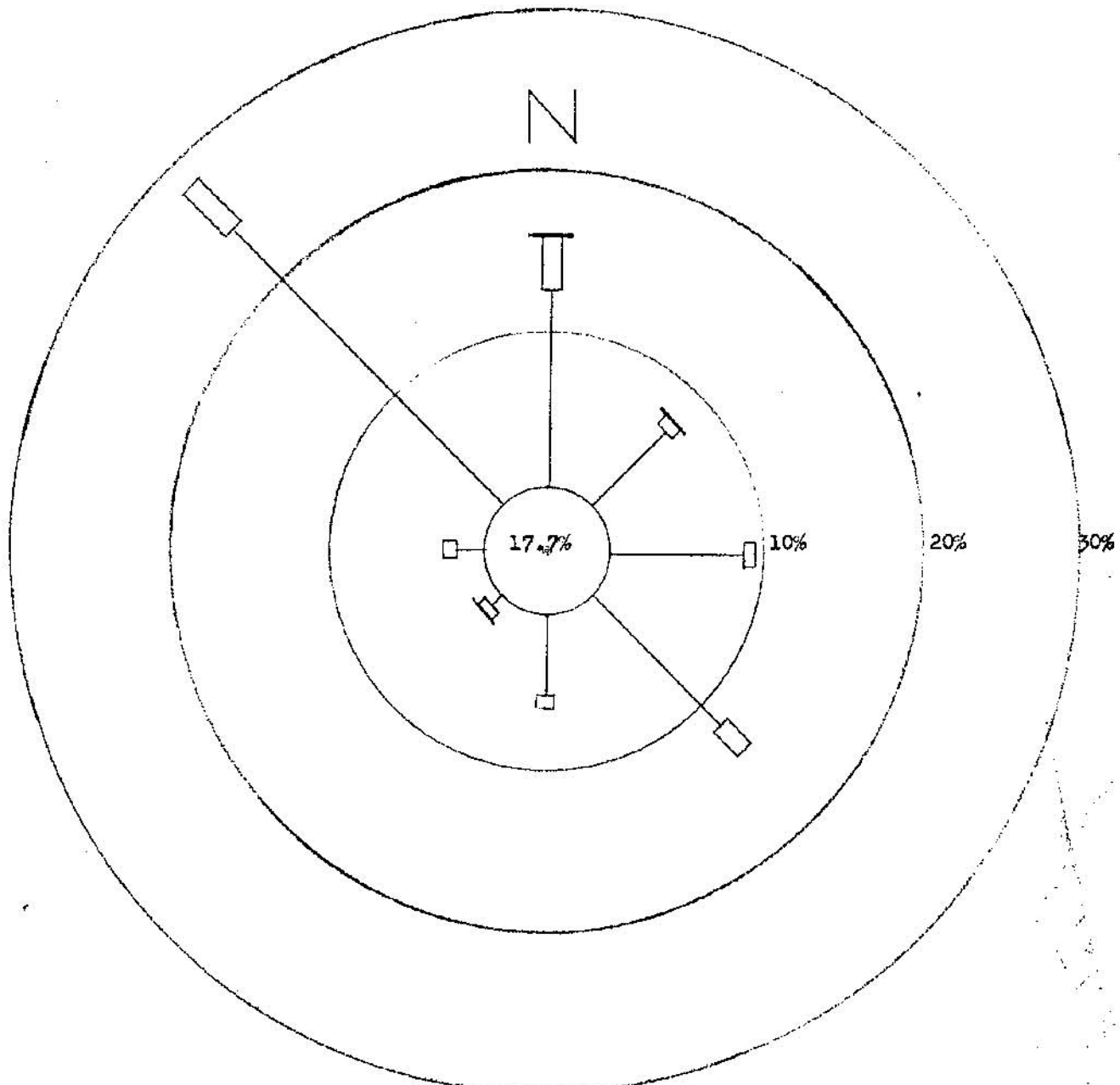

MILES PER HOUR
 3-15 15-31 31+
 % OF CALMS
 0-3
 MPH

WIND ROSE FOR SIXMONTH PERIOD, 1 JULY TO 31 DECEMBER, AT
 150 FEET ABOVE REACTOR FLOOR, OR APPROXIMATELY 2000 FEET ABOVE
 SEA LEVEL. RADIAL LINES SHOW WIND DIRECTION TOWARD CENTER OF
 WIND ROSE.

WIND ROSE
SRE - January 1959

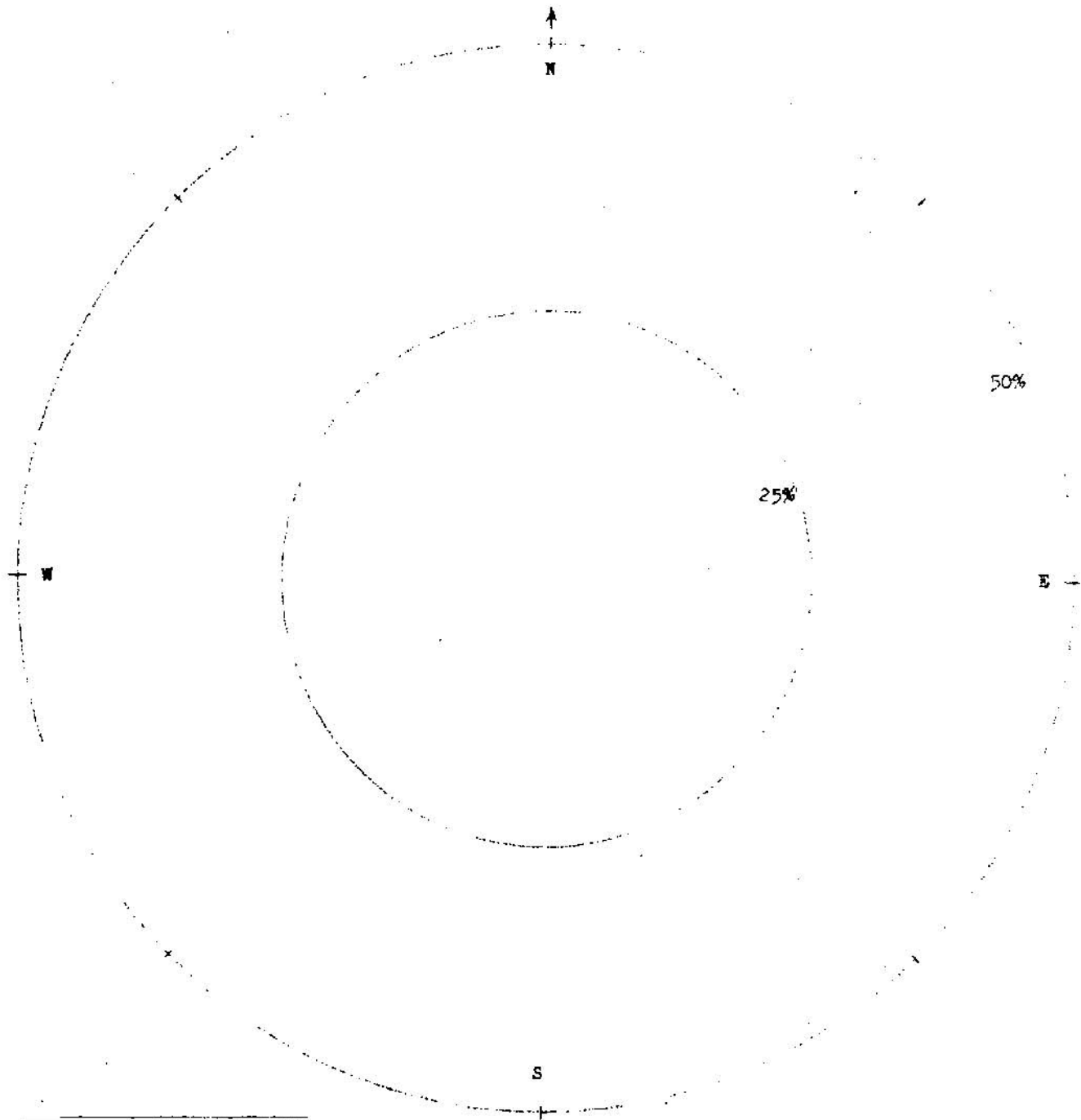

LEGEND

3 -15 15-31 31+

Windspeed
in miles per hour

Calm 0-3 MPH

Values indicated represent 100%
of possible monthly observations.

WIND ROSE
SRE - February 1959

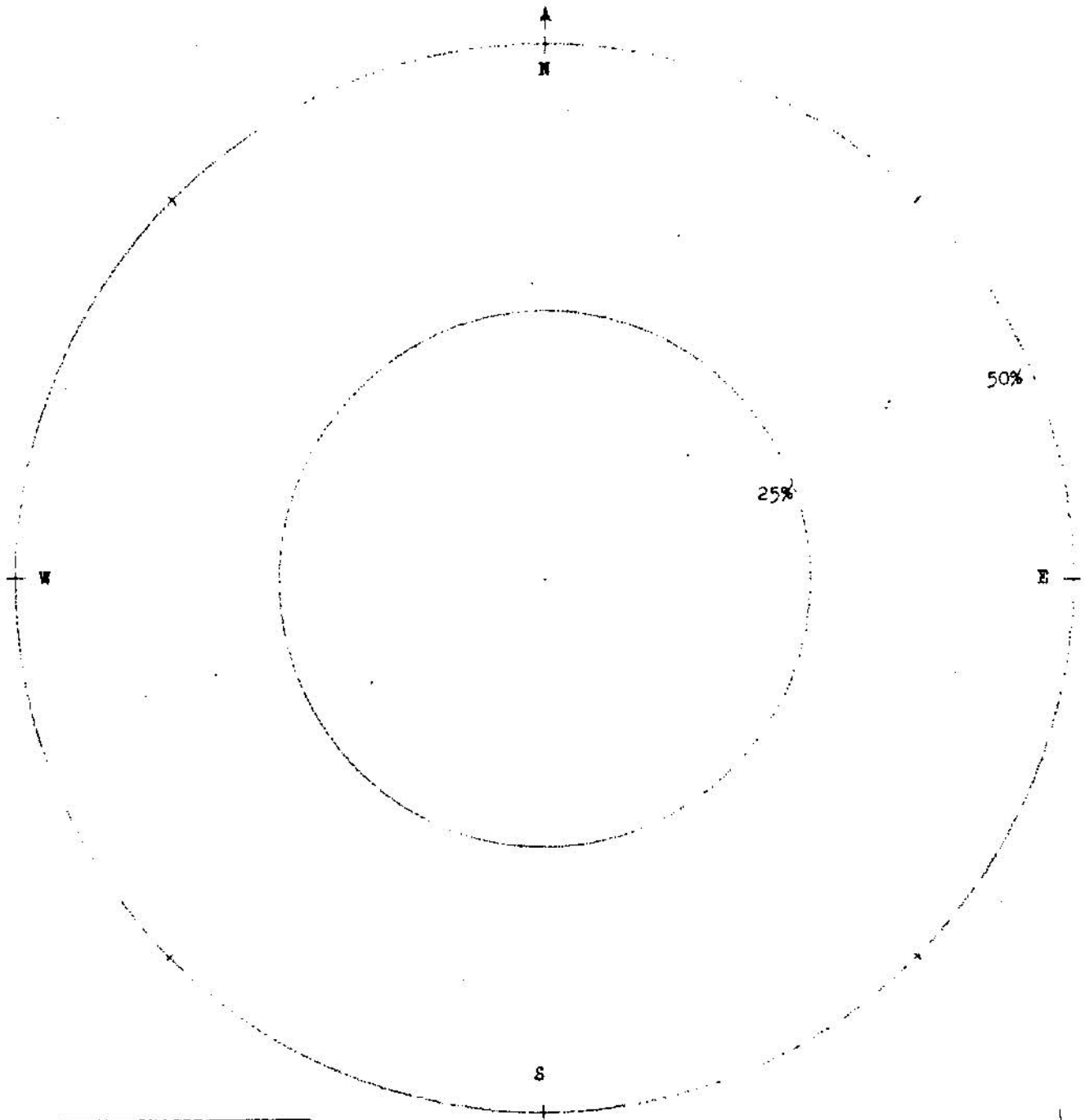

LEGEND			
3-15	15-31	31+	
Windspeed in miles per hour			

Calm 0-3 MPH

Values indicated represent 100%
of possible monthly observations.

WIND ROSE
SRE AUGUST 1960

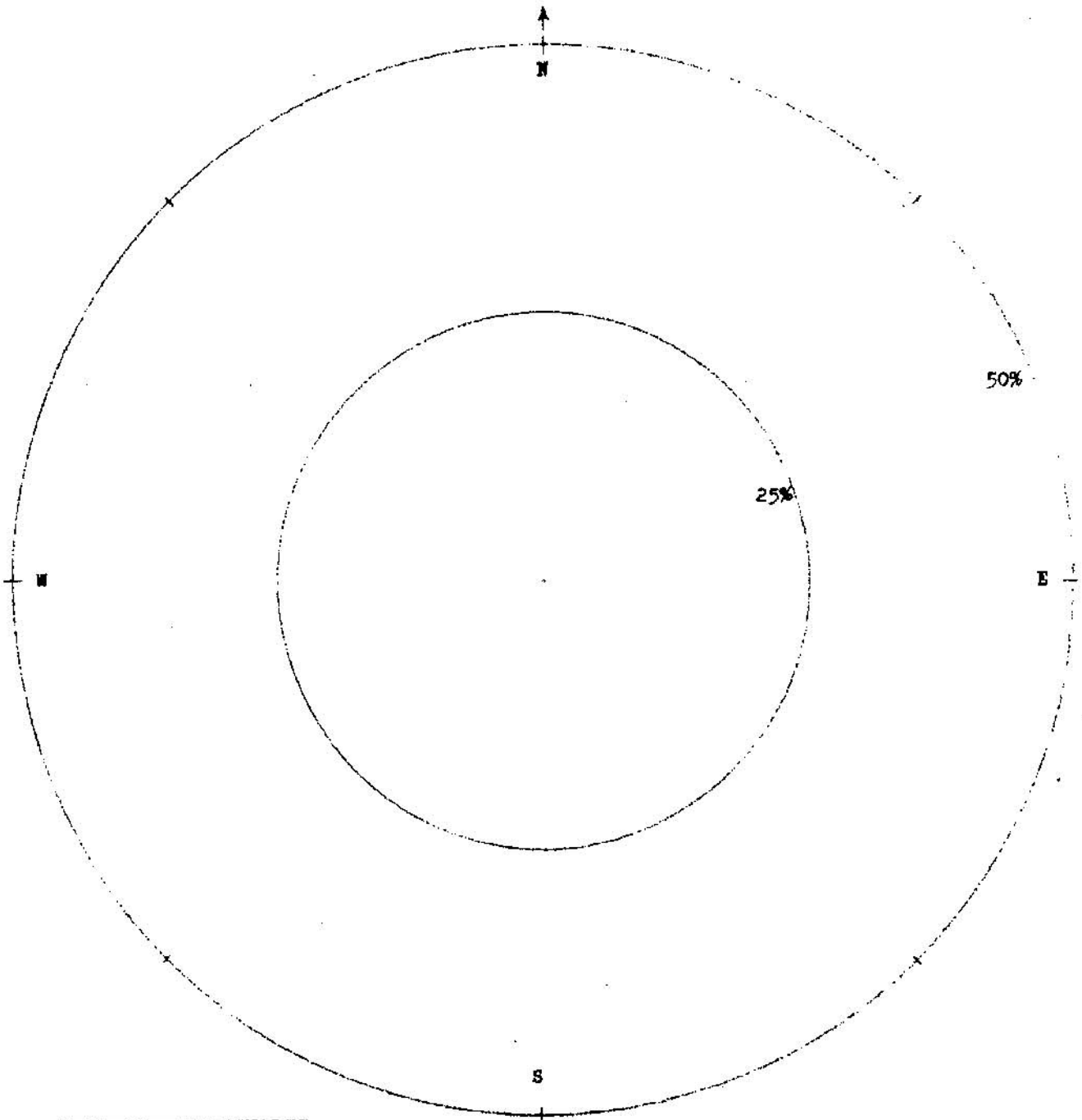

LEGEND

3 -15 15-31 31+

Windspeed
in miles per hour

Calm 0-3 MPH

No aerovane observations obtained
for month of August.

WIND ROSE
SRE SEPTEMBER 1960

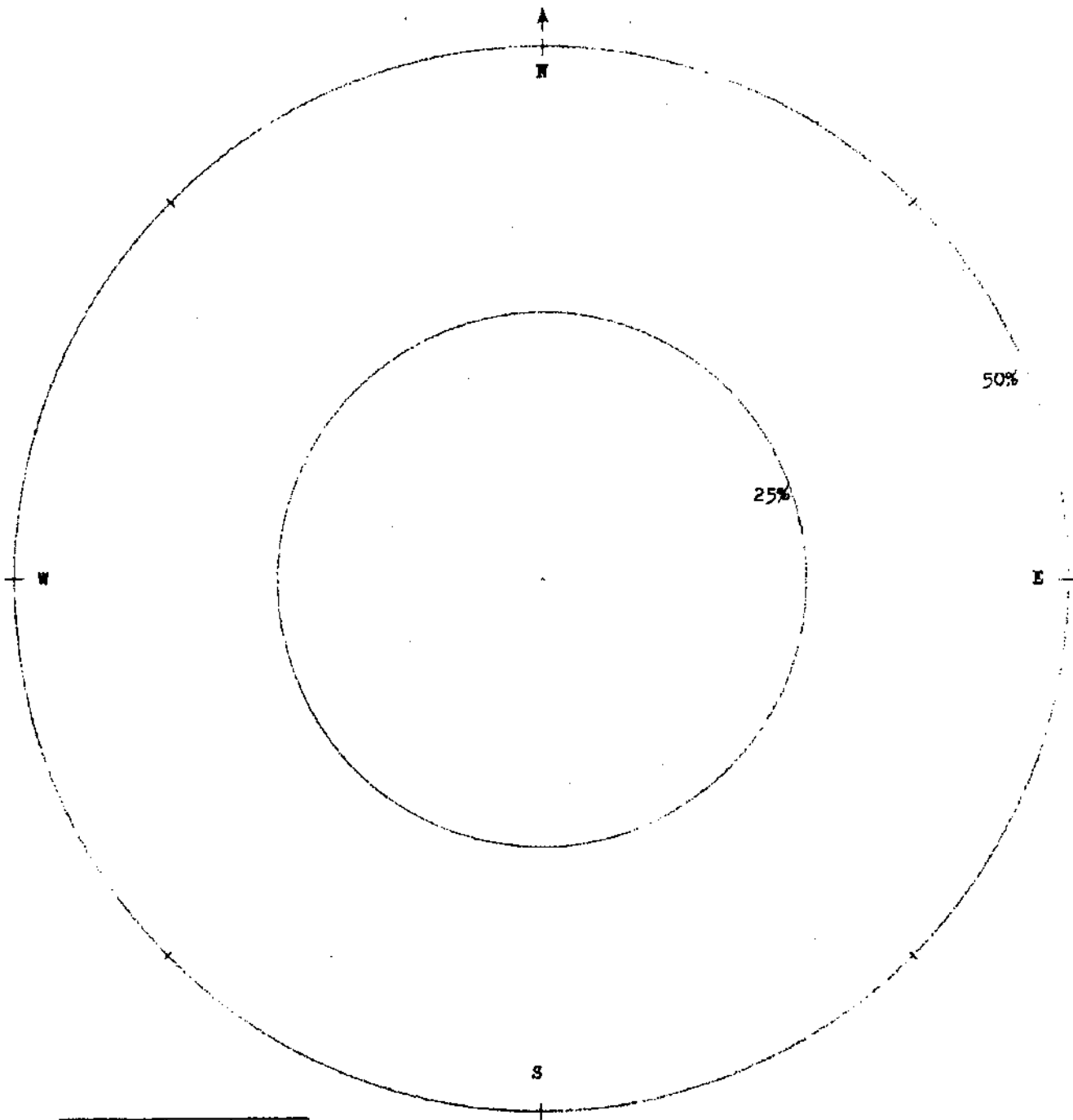

LEGEND

3 -15 15-31 31+
Windspeed
in miles per hour

No aerovane observations obtained
for month of September.

Calm 0-3 MPH

WIND ROSE
SRE October 1960

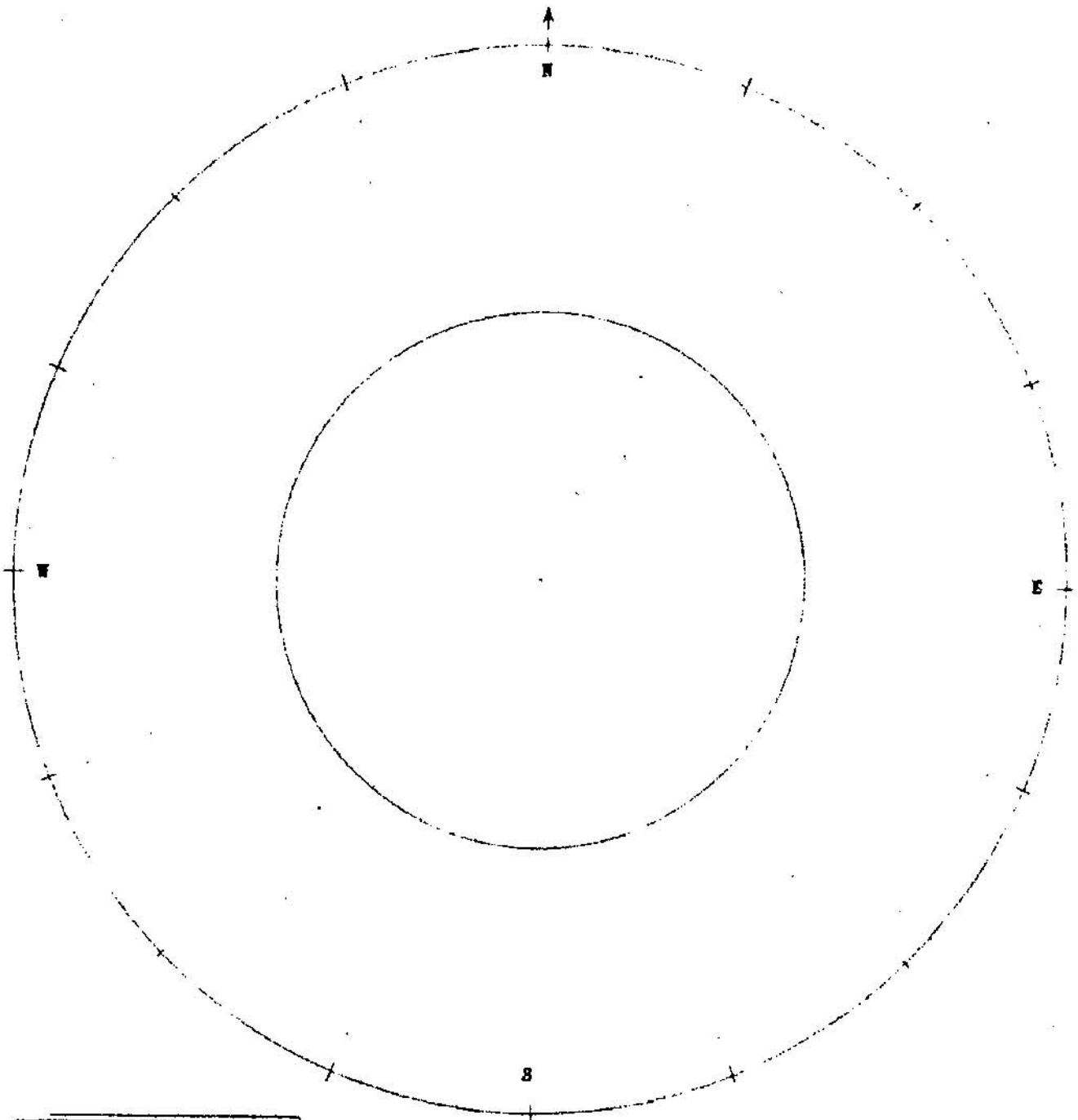

LEGEND

3 -15	15-31	31+
-------	-------	-----

Wind speed
in miles per hour

Calm 0-3 MPH _____
No anemometer observations obtained
for month of October

WIND ROSE

SRE November 1960

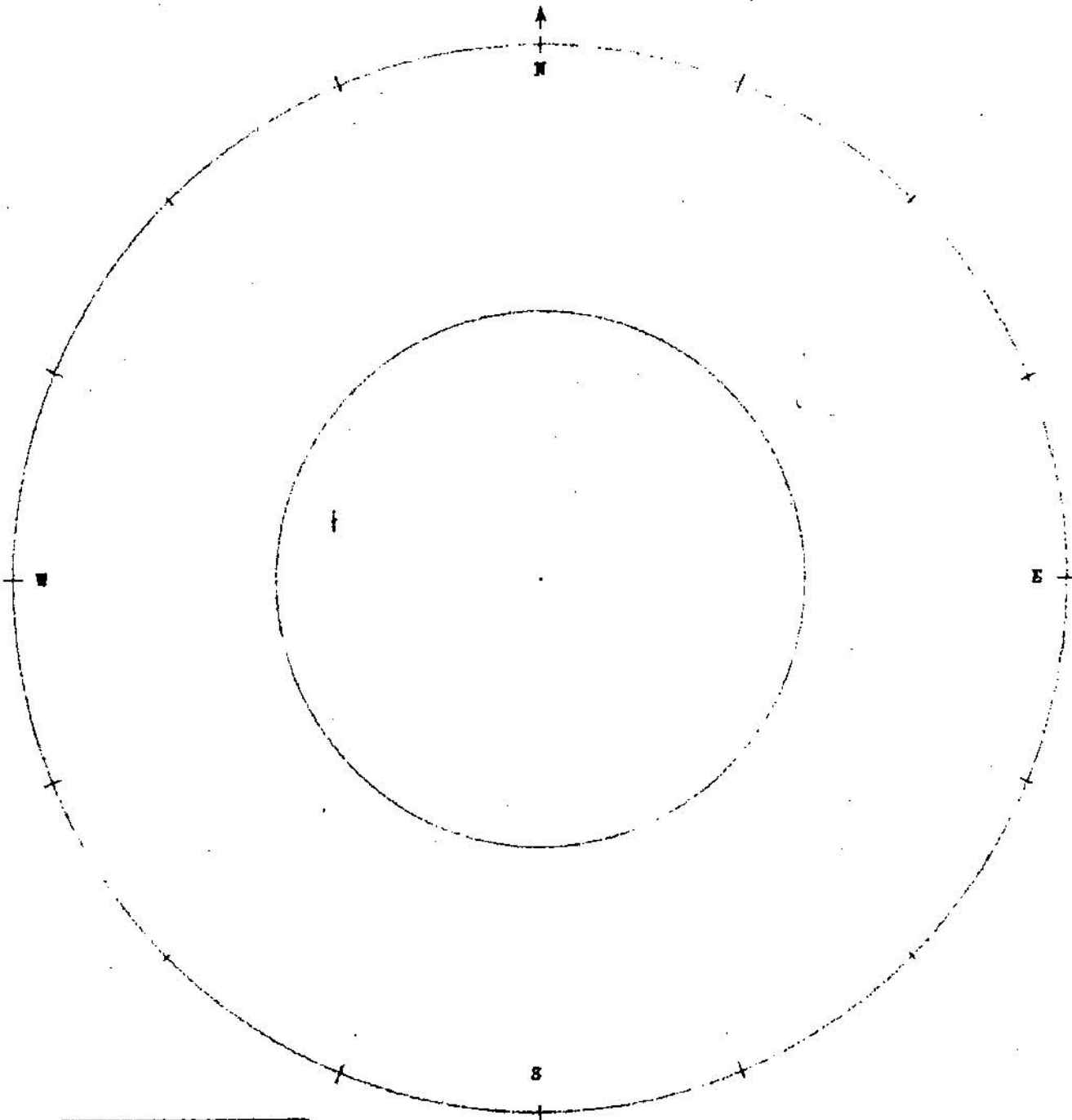

LEGEND

3 -15 15-31 31+
Windspeed
in miles per hour

Calm 0-3 MPH

No aerovane observations obtained
for month of November

WIND ROSE
SRE December 1960

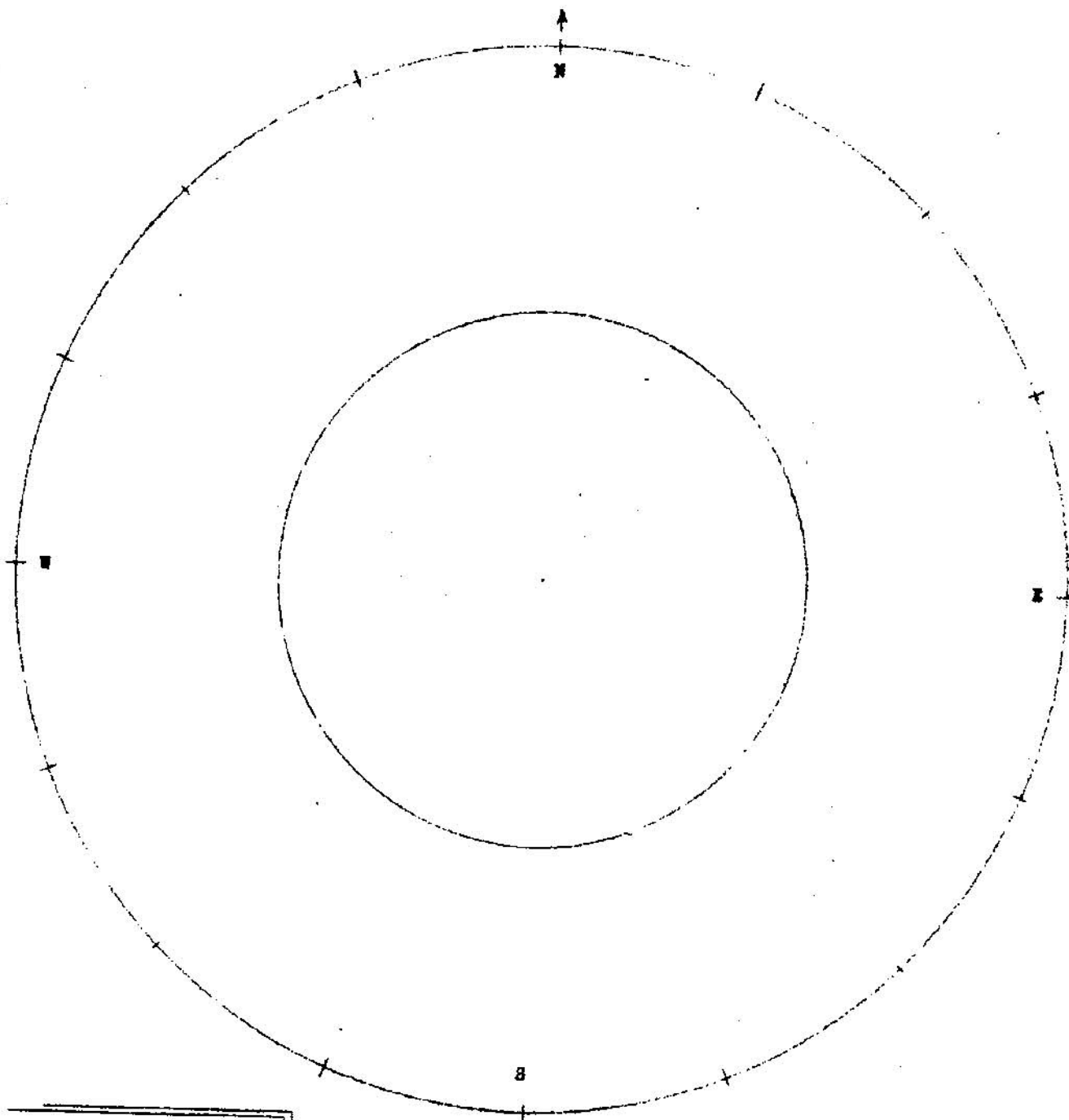

LEGEND

3 -15	15-31	31+
-------	-------	-----

Windspeed
in miles per hour

Calm 0-3 MPH _____
No aerovane observations obtained
for month of December

WIND ROSE
SRE January 1961

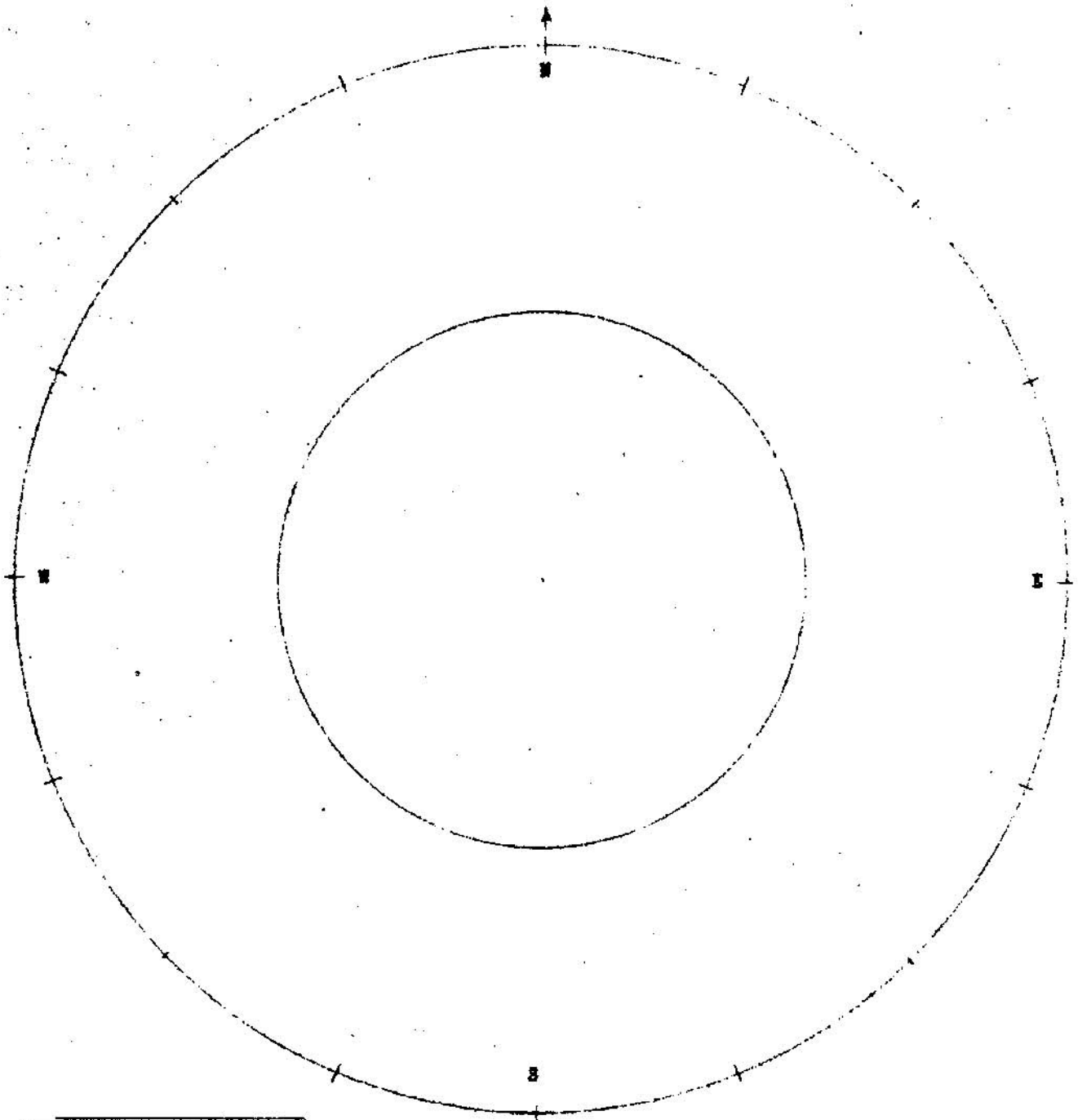

LEGEND

3 -15	15-31	31+
-------	-------	-----

Windspeed
in miles per hour

Calm 0-3 MPH

No aerovane observations obtained
for month of January

WIND ROSE
SRE February 1961

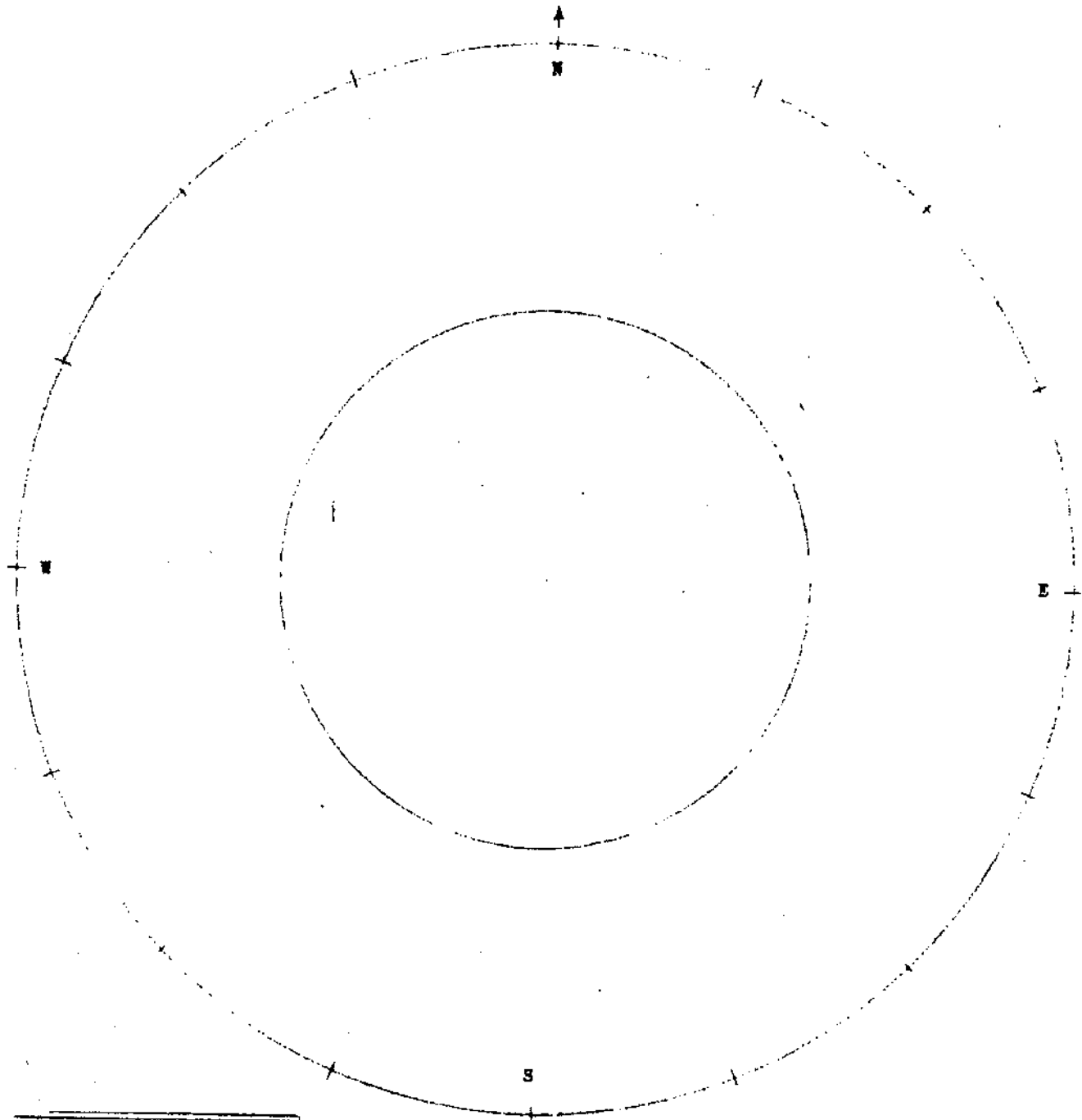

LEGEND

3 -15 15-31 31+
Windspeed
in miles per hour

No aerovane observations obtained
for month of February

Calm 0-3 MPH

WIND ROSE
 SRE
 1 JULY TO 31 DECEMBER 1957

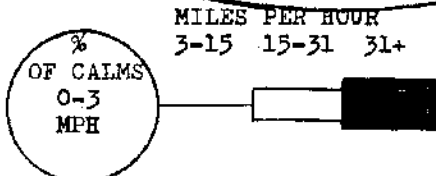
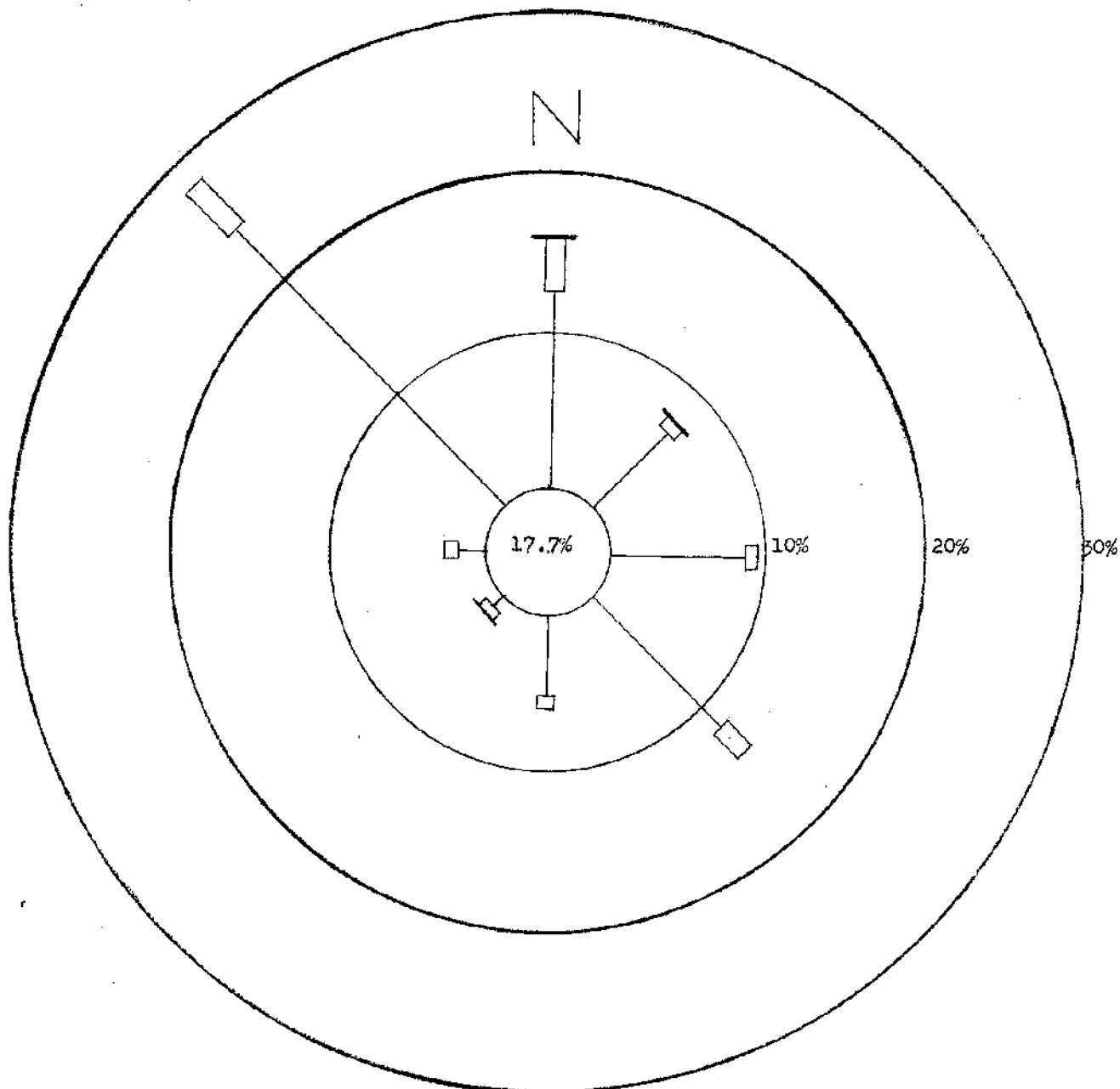

WIND ROSE FOR SIX MONTH PERIOD, 1 JULY TO 31 DECEMBER, AT 150 FEET ABOVE REACTOR FLOOR, OR APPROXIMATELY 2000 FEET ABOVE SEA LEVEL. RADIAL LINES SHOW WIND DIRECTION TOWARD CENTER OF WIND ROSE.

WIND ROSE
 SRE
 1 JULY TO 31 DECEMBER 1957

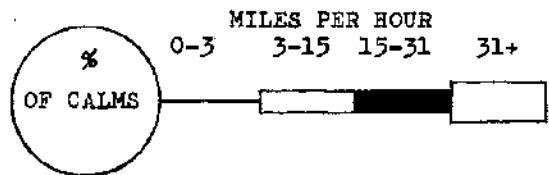
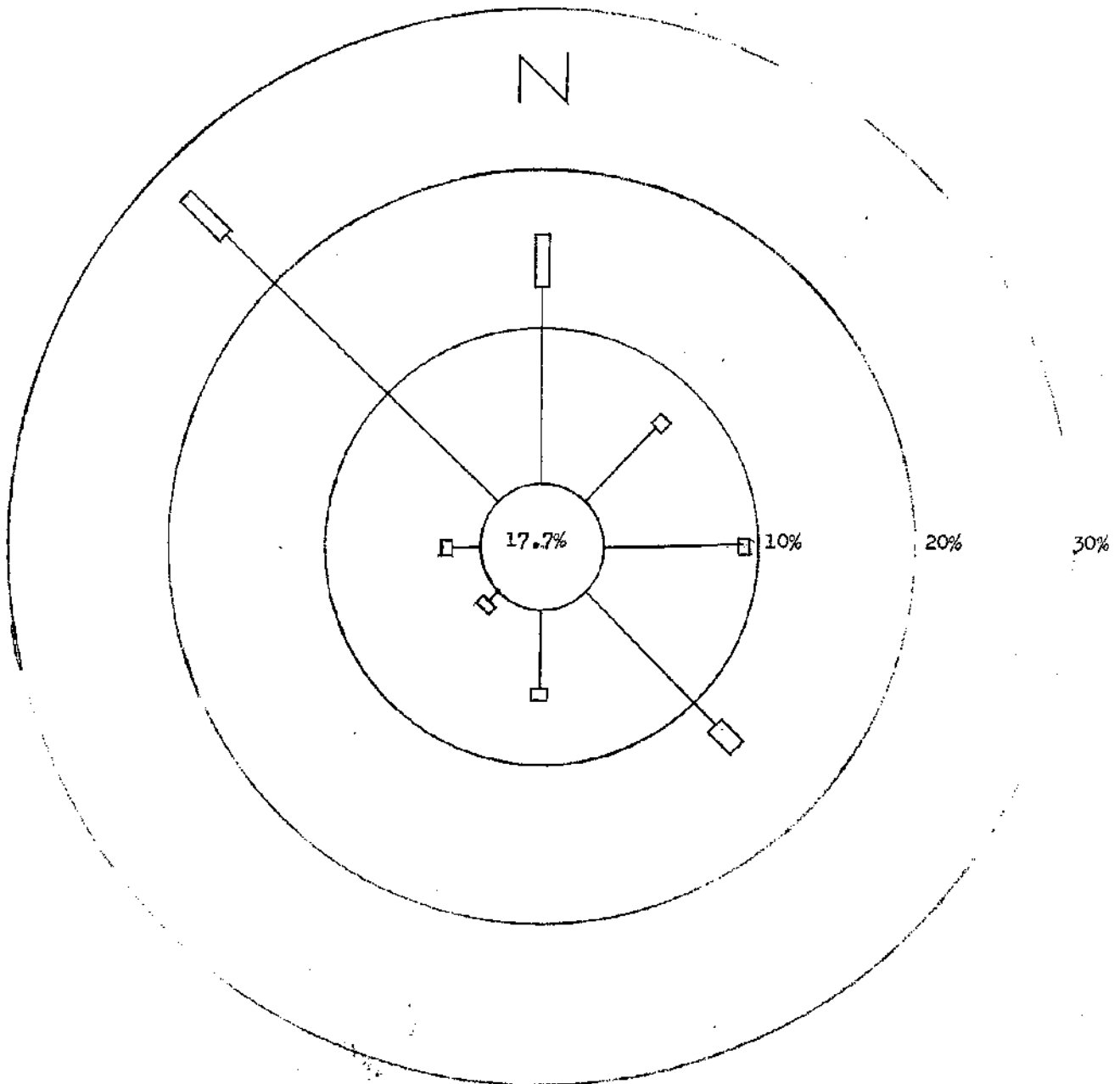

WIND ROSE FOR SIX-MONTH PERIOD, 1 JULY TO 31 DECEMBER, AT 150 FEET ABOVE REACTOR FLOOR, OR APPROXIMATELY 2000 FEET ABOVE SEA LEVEL. RADIAL LINES SHOW WIND DIRECTION TOWARD CENTER OF ROSE.

WIND ROSE
SRE
DECEMBER 1957

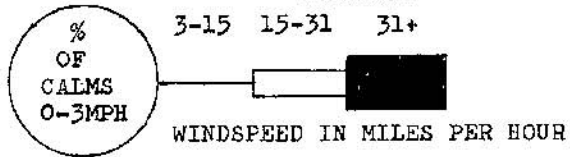
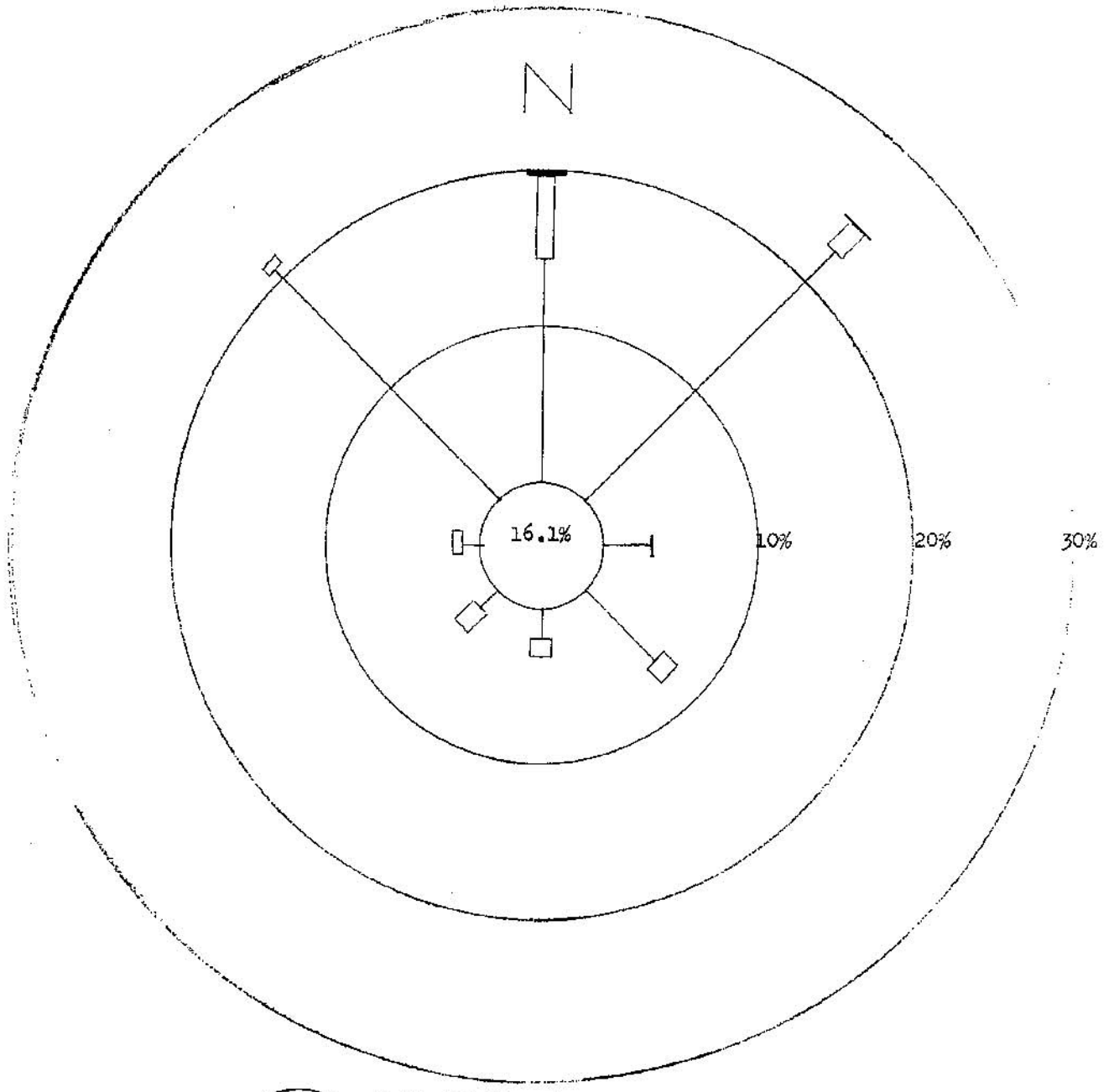

WIND ROSE
SRE
JANUARY 1957

